

**U.S. ARMY MEDICAL DEPARTMENT CENTER AND SCHOOL
FORT SAM HOUSTON, TEXAS 78234-6100**

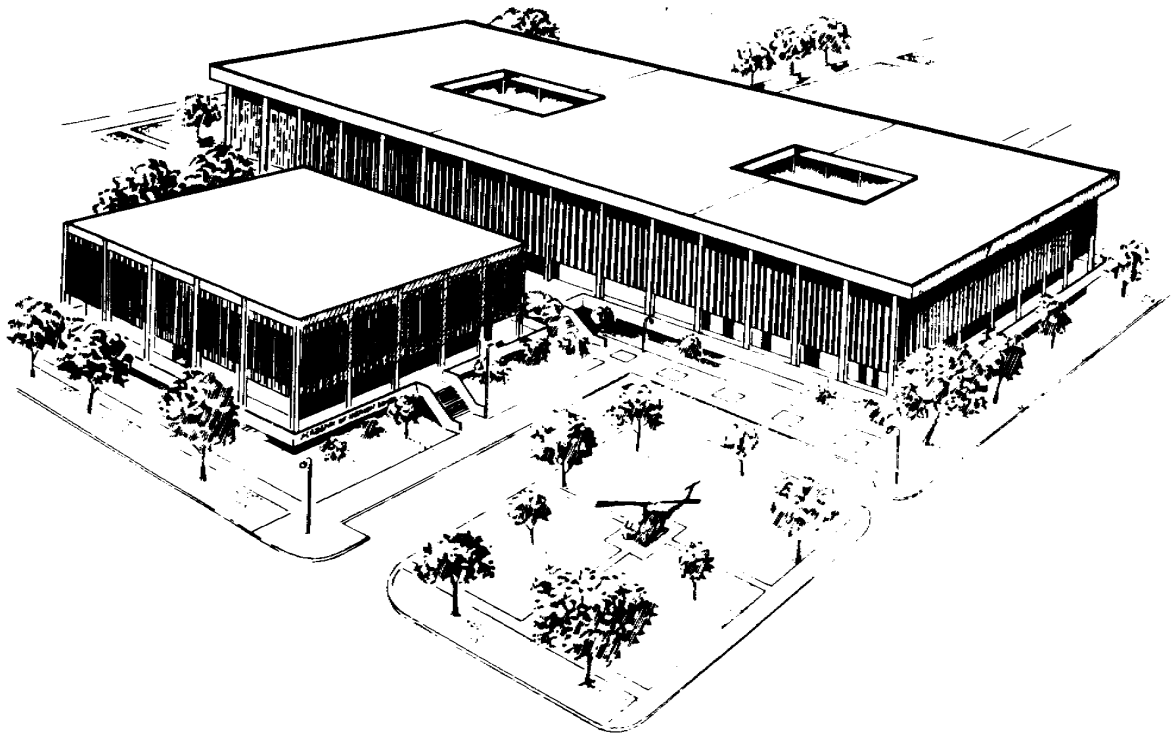

DENTAL MATERIALS

SUBCOURSE MD0502 EDITION 200

DEVELOPMENT

This subcourse is approved for resident and correspondence course instruction. It reflects the current thought of the Academy of Health Sciences and conforms to printed Department of the Army doctrine as closely as currently possible. Development and progress render such doctrine continuously subject to change.

ADMINISTRATION

Students who desire credit hours for this correspondence subcourse must enroll in the subcourse. Application for enrollment should be made at the Internet website: <http://www.atrrs.army.mil>. You can access the course catalog in the upper right corner. Enter School Code 555 for medical correspondence courses. Copy down the course number and title. To apply for enrollment, return to the main ATRRS screen and scroll down the right side for ATRRS Channels. Click on SELF DEVELOPMENT to open the application; then follow the on-screen instructions.

For comments or questions regarding enrollment, student records, or examination shipments, contact the Nonresident Instruction Branch at DSN 471-5877, commercial (210) 221-5877, toll-free 1-800-344-2380; fax: 210-221-4012 or DSN 471-4012, e-mail accp@amedd.army.mil, or write to:

NONRESIDENT INSTRUCTION BRANCH
AMEDDC&S
ATTN: MCCS-HSN
2105 11TH STREET SUITE 4191
FORT SAM HOUSTON TX 78234-5064

Be sure your social security number is on all correspondence sent to the Academy of Health Sciences.

CLARIFICATION OF TERMINOLOGY

When used in this publication, words such as "he," "him," "his," and "men" are intended to include both the masculine and feminine genders, unless specifically stated otherwise or when obvious in context.

USE OF PROPRIETARY NAMES

The initial letters of the names of some products may be capitalized in this subcourse. Such names are proprietary names, that is, brand names or trademarks. Proprietary names have been used in this subcourse only to make it a more effective learning aid. The use of any name, proprietary or otherwise, should not be interpreted as endorsement, deprecation, or criticism of a product; nor should such use be considered to interpret the validity of proprietary rights in a name, whether it is registered or not.

TABLE OF CONTENTS

<u>Lesson</u>		<u>Paragraphs</u>
	INTRODUCTION	
1	RESTORATIVE MATERIALS	
	Section I. Introduction to Dental Materials	1-1--1-4
	Section II. Dental Amalgam	1-5--1-9
	Section III. Dental Bases and Cements	1-10--1-20
	Exercises	
2	DENTAL RESINS, MISCELLANEOUS DENTAL MATERIALS, AND DENTAL GOLD/ALLOYS	
	Section I. Dental Resins for Restorative Dentistry	2-1--2-5
	Section II. Miscellaneous Dental Materials	2-6--2-10
	Section III. Dental Gold and Gold Alloys	2-11--2-20
	Exercises	
3	GYPSUM PRODUCTS, DENTAL WAXES, AND IMPRESSION MATERIALS	
	Section I. Gypsum Products	3-1--3-3
	Section II. Dental Waxes	3-4--3-11
	Section III. Impression Materials	3-12--3-23
	Exercises	

**CORRESPONDENCE COURSE OF
THE ACADEMY OF HEALTH SCIENCES, U.S. ARMY**

SUBCOURSE MD0502

DENTAL MATERIALS

INTRODUCTION

"Every tooth in a man's head is more valuable than a diamond."

From "Don Quixote"

"For there was never yet a philosopher
that could endure the toothache patiently."

William Shakespeare

The lines above hold as true today as when written more than three centuries ago!

Consider these quotations as they apply to a fighting soldier of the United States Army and you can readily understand the importance of military dentistry. A rifleman or squad leader with neglected teeth threatens the efficiency of the entire platoon. A toothache can impair physical and mental powers or even knock a man out of action. Servicemen must stay healthy, and your job as a dental specialist is to help keep them physically fit. The Dental Service is charged specifically with the conservation of oral health and with the diagnosis, prevention, and treatment of oral diseases, injuries, and deficiencies among military personnel.

This subcourse deals with the composition, property, use, and manipulation of materials used in the dental profession. This basic information is vital for the fulfillment of your role in assisting the dental officer toward the successful accomplishment of the mission of the Army Dental Service.

Subcourse Components:

This subcourse consists of three lessons. The lessons are as follows:

Lesson 1, Restorative Materials.

Lesson 2, Dental Resins, Miscellaneous Dental Materials, and Dental Gold/Alloys.

Lesson 3, Gypsum Products, Dental Waxes, and Impression Materials.

Here are some suggestions that may be helpful to you in completing this subcourse:

--Read and study each lesson carefully.

--Complete the subcourse lesson by lesson. After completing each lesson, work the exercises at the end of the lesson, marking your answers in this booklet.

--After completing each set of lesson exercises, compare your answers with those on the solution sheet that follows the exercises. If you have answered an exercise incorrectly, check the reference cited after the answer on the solution sheet to determine why your response was not the correct one.

Credit Awarded:

Upon successful completion of the examination for this subcourse, you will be awarded 10 credit hours.

To receive credit hours, you must be officially enrolled and complete an examination furnished by the Nonresident Instruction Branch at Fort Sam Houston, Texas.

You can enroll by going to the web site <http://atrrs.army.mil> and enrolling under "Self Development" (School Code 555).

A listing of correspondence courses and subcourses available through the Nonresident Instruction Section is found in Chapter 4 of DA Pamphlet 350-59, Army Correspondence Course Program Catalog. The DA PAM is available at the following website: <http://www.usapa.army.mil/pdffiles/p350-59.pdf>.

LESSON ASSIGNMENT

LESSON 1

Restorative Materials.

LESSON ASSIGNMENT

Paragraphs 1-1 through 1-20.

LESSON OBJECTIVES

After completing this lesson, you should be able to:

- 1-1. Identify terms related to dental restorative materials.
- 1-2. Identify the composition and properties of dental amalgam.
- 1-3. Identify the preparation procedures for dental amalgam.
- 1-4. Identify mercury hygiene practices.
- 1-5. Identify the composition and properties of zinc phosphate cement.
- 1-6. Identify the preparation procedures for zinc phosphate cement.
- 1-7. Identify the characteristics and preparation procedures for polycarboxylate cement.
- 1-8. Identify the characteristics and preparation procedures for glass ionomer cement.
- 1-9. Identify the characteristics and clinical uses of zinc oxide and eugenol.

SUGGESTION

After studying the assignment, complete the exercises at the end of this lesson. These exercises will help you to achieve the lesson objectives.

LESSON 1

RESTORATIVE MATERIALS

Section I. INTRODUCTION TO DENTAL MATERIALS

1-1. GENERAL

Dental materials used in the dental profession are indeed many, varied, and complex. The dental specialist who prepares and uses many of these materials in assisting the dental officer must know their composition, properties, uses, and manipulation. Restorative materials, miscellaneous dental materials, dental waxes, gypsum products, and impression materials are covered in this subcourse. A thorough knowledge of dental materials and the skill to manipulate these materials is one of the important duties of a dental specialist.

1-2. RESTORATIVE MATERIALS - GENERAL

Restorative materials are the metallic or nonmetallic materials used to restore diseased or damaged teeth to health and function. Restorative materials have been greatly improved, although a universally ideal, restorative material has not yet been developed. The corrosive nature of saliva and the expansion and contraction of tooth structure with changes in temperature make great demands upon a restorative material. The stress brought to bear on the restoration by masticatory forces also makes great demands. Restorative materials must be compatible with living tissue. If used in the anterior region of the mouth, the materials must also be esthetically pleasing. Restorative materials, used when and where indicated, help to ensure the placement of a successful restoration and preservation of the tooth.

1-3. PHYSICAL PROPERTIES OF MATERIALS

Definite and precise terms are used to describe the physical properties of dental materials. These terms must be clearly defined in order for one to understand the interrelationships between physical properties, structures, and composition. The following definitions apply to metals or alloys used in the Army Dental Service.

a. **Hardness.** Hardness is the measure of the resistance of a metal to indentation or scratching. It is an indication of the strength and wear ability of an alloy or metal.

b. **Ductility.** Ductility is the measure of the capacity of a metal to be stretched or drawn by a pulling or tensile force without fracturing. This property permits a metal to be drawn into a thin wire.

c. **Malleability.** Malleability is the measure of the capacity of a metal to be extended in all directions by a compressive force, such as rolling or hammering. This property permits a metal to be shaped into a thin sheet or plate.

d. **Flexibility and Elasticity.** These terms differ in their technical definition, but they are very closely related. Flexibility is the characteristic of a metal that allows it to deform temporarily. The elasticity of a metal is used when it returns to its original shape when the load or force is removed.

e. **Fatigue.** Fatigue is the property of a metal to tire and to fracture after repeated stressing at loads below its proportional limit.

f. **Structure (Crystalline or Grain Structure).** Metals are crystalline and many of their physical properties depend largely upon the size and arrangement of their minute crystals called grains.

(1) Grain size. The size of the grains in a solidified metal depends upon the number of nuclei of crystallization present and the rate of crystal growth. In the practical sense, the faster a molten is cooled to solidification, the greater will be the number of nuclei and the smaller will be the grain size. Generally speaking, small grains arranged in an orderly fashion give the most desirable properties.

(2) Grain shape. The shape of the grains is also formed at the time of crystallization. If the metal is poured or forced into a mold before cooling, the grains will be in a flattened state. Metal formed by this method is known as cast metal. If the metal is shaped by rolling, bending, or twisting, the grains are elongated and the metal becomes a wrought wire.

g. **Crushing Strength.** Crushing strength is the amount of resistance of a material to fracture under compression.

h. **Thermal Conductivity.** Thermal conductivity is defined as the ability of a material to transmit heat or cold. A low thermal conductivity is desired in restorative materials used on the tooth whereas a high thermal conductivity is desirable where the material covers soft tissue.

1-4. METALLURGICAL TERMS

a. **Cold Working.** This is the process of changing the shape of a metal by rolling, pounding, bending, or twisting at normal room temperature.

b. **Strain Hardening.** This occurs when a metal becomes stiffer and harder because of continued or repeated application of a load or force. At this point, no further slippage of the atoms of the metal can occur without fracture.

c. **Heat Softening Treatment (Annealing).** This treatment is necessary in order to continue manipulating a metal after strain hardening to prevent it from fracturing. The process of annealing consists of heating the metal to the proper temperature (as indicated by the manufacturer's instructions) and cooling it rapidly by immersing in cold water. Annealing relieves stresses and strains caused by cold working and restores slipped atoms within the metal to their regular arrangement.

d. **Heat Hardening Treatment (Tempering).** This treatment is necessary to restore to metals properties that are decreased by annealing and cold working. Metals to be heat hardened should first be heat softened (annealed) so that all strain hardening is relieved and the hardening process can be properly controlled. Heat hardening is accomplished in dental gold alloy by heating to 840° Fahrenheit, allowing it to cool slowly over a 15-minute period to 480° Fahrenheit, and then immersing it in water.

Section II. DENTAL AMALGAM

1-5. DENTAL AMALGAM

a. **History of Amalgam.** Dr. G. V. Black investigated the properties of amalgams and their possible use for dentistry about 1895. His studies showed the effects of chemical composition and physical structure on the properties of amalgam restorations. Due largely to the work done by Dr. Black, the National Bureau of Standards, and other researchers, amalgam is now used more than any other filling material for the restoration of posterior teeth.

b. Definitions.

(1) Alloy. An alloy is a solid mixture of two or more metals. It is possible to produce a material in which the desirable properties of each constituent are retained or even enhanced while the less desirable properties are reduced or eliminated. With few exceptions, the metals used in dentistry are in fact alloys.

(2) Amalgam. When one of the metals in an alloy mixture is mercury, an amalgam is formed. A dental amalgam is a combination of mercury with a specially prepared silver alloy. It is used as a restorative material.

(3) Mercury. Mercury is a silver-white, poisonous, metallic element that is liquid at room temperature (symbol Hg).

c. Composition and Effects of Amalgam.

(1) Combining desirable properties. Each metal incorporated into a dental silver alloy has specific properties when combined with mercury. Some properties are desirable and some are undesirable. An acceptable alloy is balanced. The combined effects of the properties of its ingredients should provide the most satisfactory restorative material.

(2) Standards and requirements. Like other restorative materials, amalgam must meet the standards and requirements set by the National Bureau of Standards and the American Dental Association's (ADA) Specification number one for alloy used in amalgam.

(3) Composition of the alloy. The ADA specification states that the composition of the alloy must include a minimum of 65 percent silver, a maximum of 29 percent tin, a maximum of 6 to 13 percent copper, and a maximum of two percent zinc by weight (see figure 1-1).

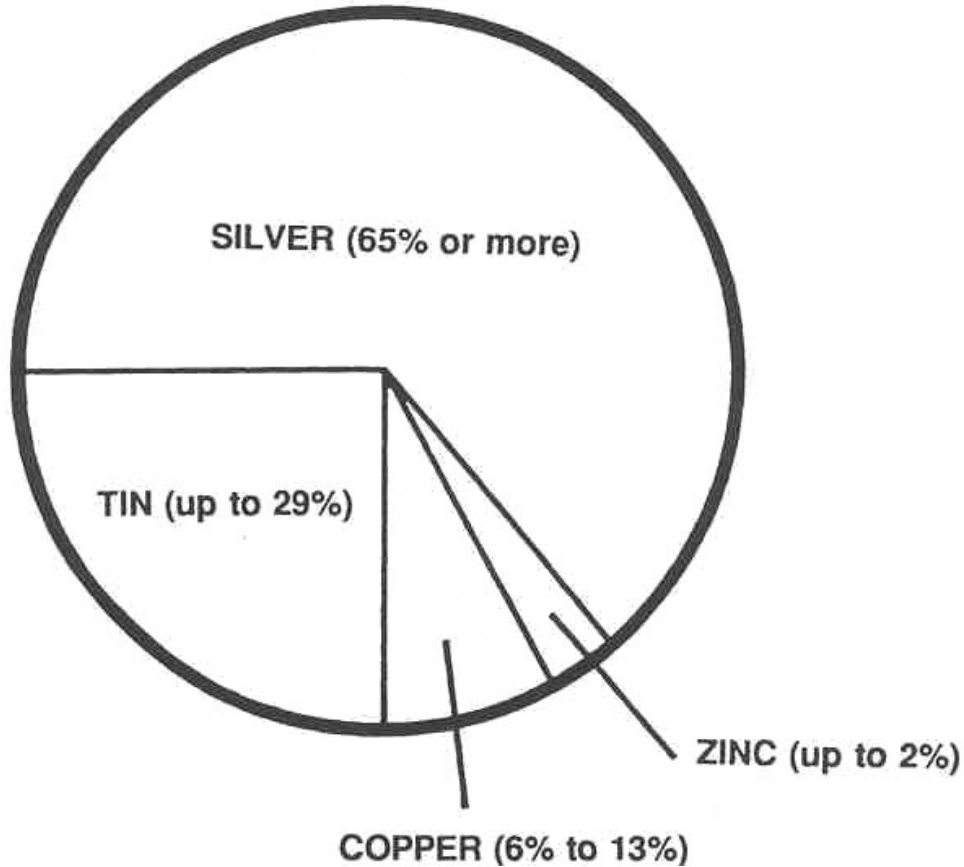

Figure 1-1. Approximate composition of an acceptable amalgam alloy.

(4) Correct proportion important. Immediately prior to use, the silver alloy is mixed with pure and uncontaminated mercury. (Mercury, although an indispensable ingredient, imparts undesirable properties to the amalgam if added in incorrect proportions.) There are some alloys that are completely zinc free. They can therefore be used more successfully in a moisture-contaminated environment.

(5) Properties of the finished product. Each element composing amalgam imparts certain properties to the finished product. Table 1-1 summarizes these properties. Silver imparts strength, durability, and color, gives the alloy desirable setting expansion, decreases flow, and accelerates (decreases) the setting time. Tin makes the amalgam easier to work, controls excessive setting expansion, and increases both flow and setting time. Copper increases hardness, contributes to setting expansion, reduces flow, and decreases setting time. Zinc increases workability and unites with oxygen and other "impurities" to produce a clean amalgam.

PROPERTY	INGREDIENT			
	Silver	Tin	Copper	Zinc
Strength	Increases			
Durability	Increases			
Hardness			Increases	
Expansion	Increases	Decreases	Increases	
Flow	Decreases	Increases	Decreases	
Color	Imparts			
Setting time	Decreases	Increases	Decreases	
Workability		Increases		Increases
Cleanliness				Increases

Table 1-1. Effects on properties of an amalgam restoration imparted by ingredients.

d. **Physical Properties of Amalgam.** The most important physical properties of amalgam are flow and creep, dimensional change, and strength.

(1) Flow and creep. Flow and creep are characteristics that deal with an amalgam undergoing deformation when stressed. The lower the creep value of an amalgam, the better the marginal integrity of the restoration. Alloys with high copper content usually have lower creep values than the conventional silver-tin alloys.

(2) Dimensional change. An amalgam can expand or contract depending upon its usage. Dimensional change can be minimized by proper usage of alloy and mercury.

(3) Compression strength. Sufficient strength to resist fracture is an important requirement for any restorative material. At 50 percent mercury content, the compression strength is approximately 52,000 pounds per square inch (psi). In comparison, the compressive strength of dentin and enamel is 30,000 psi and 100,000 psi, respectively. The strength of an amalgam is determined primarily by the composition of the alloy, the amount of residual mercury remaining after condensation, and the degree of porosity in the amalgam restoration.

1-6. ADVANTAGES AND DISADVANTAGES OF AMALGAM

a. **Advantages.** Amalgam has many advantages over other materials as a restorative material. Amalgam is used more than any other material to restore carious teeth. It is easy to insert into the cavity preparation and adapts readily to cavity walls. In obtaining its initial set, or hardness, amalgam allows time for condensing and carving. It has an acceptable crushing strength and is recognized as having a long life as a restoration. As an amalgam restoration ages in the oral cavity, corrosion products form along the restoration-tooth interface. These compounds act as a mechanical block to micro-leakage and account for the excellent clinical results obtained with silver amalgam.

b. **Disadvantages.** Amalgam has many disadvantages as a restorative material. Because amalgam's color does not match the color of the teeth, it is generally not used on the visible surfaces of anterior teeth. Amalgam will tarnish with time, no matter how well the amalgam restoration is prepared and inserted. To avoid or to reduce tarnish, the restoration is smoothed and highly polished a day or two after its insertion. The restoration may be repolished later at any time with little effort. Amalgam will also conduct heat or cold readily (high thermal conductivity). If the amalgam is placed too close to the pulp, it may irritate the pulp. Therefore, an intermediate base that will not conduct heat or cold as readily (low thermal conductivity) is placed under the amalgam.

1-7. USAGE AND PREPARATION OF AMALGAM

a. **General.** The dental specialist has the direct responsibility for the correct preparation and use of amalgam. Incorrect use may produce a faulty restoration that can cause or contribute to the loss of a tooth. Therefore, the dental specialist must use extreme care in preparing a good mix of amalgam that will provide the best qualities obtainable from the alloy.

b. **Trituration of Amalgam.** Trituration, or amalgamation, is the mechanical mixing of the alloy and mercury which, when mixed, forms the mass of amalgam needed to restore the tooth. Trituration is done by a mechanical amalgamator (see figure 1-2). Trituration is done by setting the timer according to the manufacturer's instructions for the alloy and for the type amalgamator used. Special capsules are furnished with the mechanical amalgamator to hold the alloy-mercury mixture during trituration. Each capsule is preloaded with amalgam alloy and liquid mercury and a small rod-like pestle that aids in the mixing process. The amalgamator mixes the amalgam in the capsule by rapid shaking or vibration. This produces a consistently uniform mix. The amalgamator reduces trituration to a matter of seconds. When the time selected has elapsed, the automatic timer will stop the machine. The dental specialist must be careful not to overtriturate or undertriturate. Overtrituration results in shorter setting time and increased shrinkage. Undertrituration results in increased expansion, lengthened setting time, and weakened amalgam.

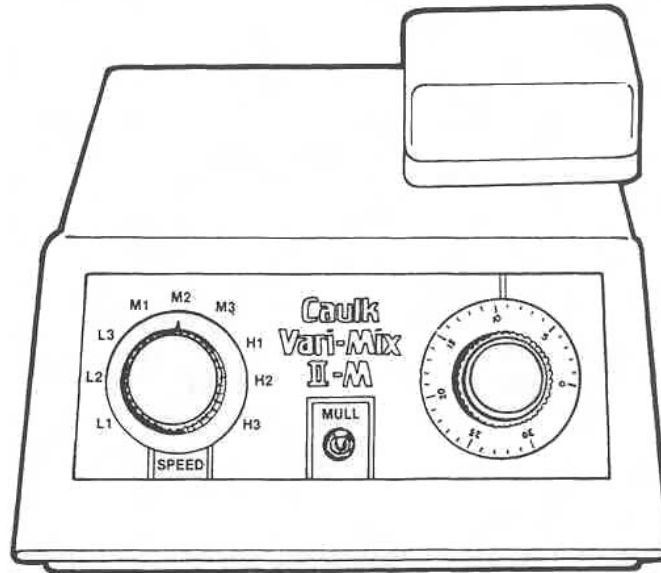

Figure 1-2. Mechanical amalgamator.

c. **Filling Amalgam Carrier.** Modern dental amalgams use precise proportioning methods for dispensing the mercury with the alloy. Since the mercury content in the original mix is less than the maximum level of 55 percent, it is not necessary to eliminate mercury from the amalgam before it is carried to the cavity preparation. The amalgam is taken from the capsule and placed in an amalgam cup. The amalgam carrier is loaded by forcing the open cylinder of the amalgam carrier into the balled amalgam. The amalgam is then carried to the mouth and deposited in the cavity preparation.

d. **Condensation and Carving of Amalgam.** Condensation is the process of packing an amalgam mix into a cavity preparation. Both time and pressure are important to achieve the best results. Condensation must be accomplished before crystals start to form. Delay will result in a breakdown of these crystals and a weakened amalgam. Sufficient condensation pressure is necessary to prevent voids in the restoration. The amount of pressure varies with each type of amalgam. Usually the amalgam restoration is well set and hardened so that carving can be started with sharp instruments immediately after condensation. The carving operation results in a completely restored tooth.

1-8. PRECAUTIONS DURING AMALGAM PREPARATION

a. Moisture Contamination.

- (1) Four possible adverse effects.
 - (a) Excessive expansion of the amalgam.
 - (b) Postoperative pain.

- (c) Lowered crushing strength.
- (d) Blister formation on the surface of the amalgam.

(2) Avoidance procedures. Moisture can be introduced into amalgam by triturating below the dew point (temperature at which moisture collects on a surface). Moisture can also be introduced by the presence of moisture in the cavity being filled or by accidental contact with saliva. To avoid moisture contamination, all instruments and equipment encountering the amalgam should be dry. The temperature of equipment and materials should be high enough so that no moisture collects. Saliva should be kept out of the cavity preparation during the insertion of the material.

b. **Guidance for Amalgam Preparation.** Any portion of amalgam that is too dry or has begun to crystallize must be discarded. Its use would result in a weak, nonhomogeneous mass. For large restorations, it may be necessary to prepare two or more mixes. Each mix is prepared as needed.

c. **Training of Personnel Required.** All dental personnel must be familiar with the potential hazards and the proper handling of mercury.

1-9. MERCURY HYGIENE PRACTICES BY THE DENTAL SPECIALIST

a. **General.** Amalgam restorations do not constitute a hazard to patients. However, dental personnel may invite a health hazard if exposed to concentrated mercurial vapors over an extended period of time. Mercury hygiene precautions should be used.

b. Mercury Hygiene Precautions.

(1) Training. All dental personnel must be instructed regarding the potential health hazards of mercury and what constitutes proper handling.

(2) Covering cuts and abrasions. All cuts and abrasions of the skin must be covered when handling amalgam or mercury.

(3) Washing hands and arms. All dental personnel must wash hands and arms thoroughly after amalgam operations.

(4) Inspection of capsules. Capsules must be checked for general condition and seal. Cracked capsules or those in poor condition will be discarded.

(5) Use of masks. All dental personnel must wear masks when removing amalgam restorations.

- (6) Use of water coolant. A water coolant must be used to reduce and minimize the dispersion of particles during removal of amalgam restorations.
- (7) Use of gloves. Handling amalgam with bare hands must be avoided.
- (8) Use of standard containers. An amalgam well or a dappen dish must be used to hold prepared amalgam.
- (9) Storage of materials. Old amalgam and mercury must be stored under fresh, clean fixer solution in a strong closed container and kept in a cool, fireproof area.
- (10) Disposal of wastes. Disposable paper, cloths, and rubber items that are mercury or amalgam contaminated must be deposited into bag-lined, covered containers after use. Bag and contents must be disposed of daily.
- (11) Avoiding heat. Amalgam mixing equipment, as well as mercury, must be kept away from any source of heat.
- (12) Use of closed containers for amalgamators. Amalgamators must be kept inside closed containers as much as possible.
- (13) Weekly cleaning of amalgamators. Amalgamators must be cleaned at least once a week.
- (14) No carpeting in work area. There must be no carpeting in the part of the dental clinics where mercury or amalgam is used.
- (15) Separate area for cleaning. The cleaning area for equipment for laboratories and other clinic areas must be kept separate and distinct from the cleaning area for equipment used with amalgam or mercury in order to avoid wide dispersal of mercurial vapors.

Section III. DENTAL BASES AND CEMENTS

1-10. GENERAL

Dental cements are generally low strength materials prepared by mixing a powder with a liquid. These cements vary in their chemical composition, properties, and uses. Dental cements have lower heat conductivity than do metallic restorative materials. Dental cements, however, have the disadvantages of relatively low strength, varying degrees of solubility in mouth fluids, and setting shrinkage. As a group, they are more natural in appearance and are easier and faster to use. Although they are widely used in restorative dentistry, dental cements are considered to be among the least permanent of restorative materials. Four types of cement used in dentistry are zinc phosphate cement, polycarboxylate cement, glass ionomer cement, and zinc oxide and eugenol cement.

1-11. CHARACTERISTICS OF ZINC PHOSPHATE CEMENT

a. **History.** More than 100 years ago, a French architect proposed the use of zinc oxide as a stopping medium for carious teeth. Zinc phosphate cement has progressively advanced from the original wall plaster that induced its development over a century ago.

b. **Clinical Uses.** Zinc phosphate cement is used both as an intermediate base and as a cementing medium.

(1) Intermediate base. A thick mix of zinc phosphate cement is used as an intermediate base beneath a permanent metallic restoration. This layer of cement protects the pulp from sudden temperature changes that may be transmitted by the metallic restoration.

(2) Cementing medium. Zinc phosphate cement is used to permanently cement crowns, inlays, and fixed partial dentures upon the remaining tooth structure. It is also used to hold splints, orthodontic appliances, and other appliances in place. This cement is used to cement facings to fixed partial dentures and certain types of artificial teeth to artificial denture bases. A creamy mix of cement is used to seat the restoration or appliance completely into place. The cementing medium does not cement two objects together. Instead, the cement holds the objects together by mechanical interlocking, filling the space between the irregularities of the tooth preparation and the cemented restoration.

c. **Chemical Composition.**

(1) Powder. The primary ingredients of zinc phosphate cement powder are zinc oxide and magnesium oxide.

(2) Liquid. The liquid used with the powder is phosphoric acid and water in the ratio of two parts acid to one part water. The solution may also contain aluminum phosphate and zinc phosphate. The water content of the liquid is critical and must be carefully controlled by the manufacturer to provide a satisfactory setting time. Liquids exposed in open bottles will absorb moisture from the air in high humidity. The liquids will lose moisture if humidity is low. Water gain hastens setting; water loss lengthens setting time. Liquid that has been left unstoppered for a long period or is discolored or is the last 25 percent portion remaining in the bottle should be discarded. Since the manufacture of zinc phosphate cement is a carefully controlled process, satisfactory results can seldom be achieved by mixing the powder of one brand of cement with the liquid of another.

1-12. PROPERTIES OF ZINC PHOSPHATE CEMENT

a. **Advantages.** Some advantages of zinc phosphate cement as a cementing medium are:

- (1) Inconspicuous appearance.
- (2) Speed and ease of usage.
- (3) Sufficient flow to form a thin layer for the cementing of closely adapted crowns, fixed partial dentures, and inlays.
- (4) Low thermal conductivity beneath a metallic restoration.

b. **Disadvantages.** Some disadvantages of zinc phosphate cement as a cementing medium are:

- (1) Low crushing strength that varies between 12,000 and 19,000 psi.
- (2) Slight solubility in mouth fluids.
- (3) Opaque material not suitable for visible surfaces.

c. **Strength.** The ratio of powder to liquid increases the strength of phosphate cements to a certain point. For this reason, the dental specialist must use as thick a mix as practical for the work being performed.

1-13. SETTING REACTIONS OF ZINC PHOSPHATE CEMENT

a. **Chemical Reaction.** The chemical reaction that takes place between the powder and liquid of setting phosphate cement produces heat. The amount of heat produced depends upon the rate of reaction, the size of the mix, and the amount of heat extracted by the mixing slab.

b. **Powder to Liquid Ratio.** The less powder used in ratio to the liquid, the longer the cement will take to harden. Good technique minimizes the rise in temperature and acidity of the setting cement that can injure the pulp. Generally, for increased strength, decreased shrinkage, and resistance to solubility, it is advisable to blend as much powder as possible to reach the desired consistencies.

c. **Setting Time.** The setting time of zinc phosphate cement is normally between 5 and 9 minutes. Four actions that may be taken to maintain and prolong the normal setting time are given below.

(1) Lower the temperature of the glass mixing slab to between 65° and 75° F (18° to 24° C), if the glass mixing slab is not already cooled below the temperature at which moisture will condense on it.

(2) Blend the powder slowly.

(3) Mix the powder over a large area of the cool slab.

(4) Use a longer mixing time, within optimum limits.

1-14. PREPARATION AND USAGE OF ZINC PHOSPHATE CEMENT

a. **Equipment.** The equipment required for mixing zinc phosphate cement consists of a glass mixing slab, a stainless steel spatula, and a matched set of powder and liquid (see figure 1-3).

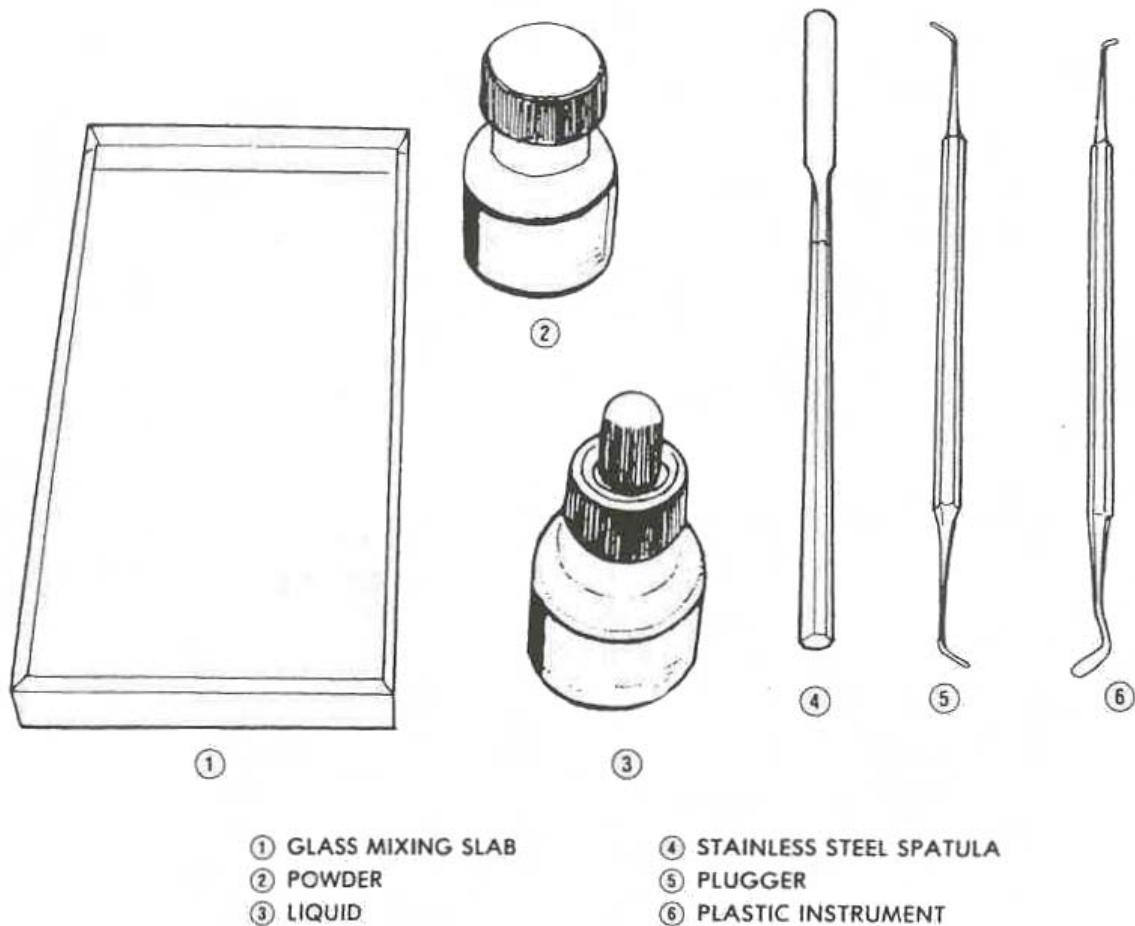

Figure 1-3. Setup for mixing zinc phosphate cement.

b. **Powder and Liquid.** The first step in preparing a mix of zinc phosphate cement is to measure the desired amount of liquid and powder onto the surface of a clean, cool, dry, glass-mixing slab. The amount of each ingredient depends upon the amount and the consistency desired. Experience gained in usage of desired consistencies enables the dental specialist to estimate accurately the amount of powder used according to the number of drops of liquid dispensed. The estimated powder is placed on one end of the slab. The powder is divided into quarters. Then, the first quarter (only) is divided in half (into eighths), and the eighth portion (only) is further divided in half (into sixteenths). When the process is completed, a total of six portions of powder are readied for mixing (see figure 1-4). An additional small amount of powder is often placed on the corner of the slab for use if the estimated powder is insufficient for the desired mix. The liquid is dispensed with the dropper supplied by the manufacturer. The required number of drops of liquid is dispensed from the dropper bottle in accordance with the manufacturer's instructions. The drops are dispensed over a wide area. The close estimation of powder, according to type of mix and number of drops, and the small increments will enhance the slow blending of powder. This slows the setting reaction and enables the user to blend the maximum amount of powder to attain desired consistency. This will help obtain cement with optimum physical properties.

c. **Mixing.** Mixing is done by the slow blending of the segments one at a time. This procedure aids in neutralizing the acid and achieving a smooth consistency. A considerable portion of the slab is used. Mixing is done with a moderate circular motion of the spatula blade held flat against the slab. The spatula should be rotated occasionally to blend the material that collects on the top of the blade. A good rule is to spatulate the first three segments for about 15 seconds. (See figure 1-4.) The next two segments should be spatulated for about 20 seconds. The final segment should be spatulated for 30 to 35 seconds. If this is done, the mixing time is not critical and completion of the mix will take about 1 1/2 minutes. It is important to reach the desired consistency by using more powder and not to allow a thinner mix to stiffen by crystallization.

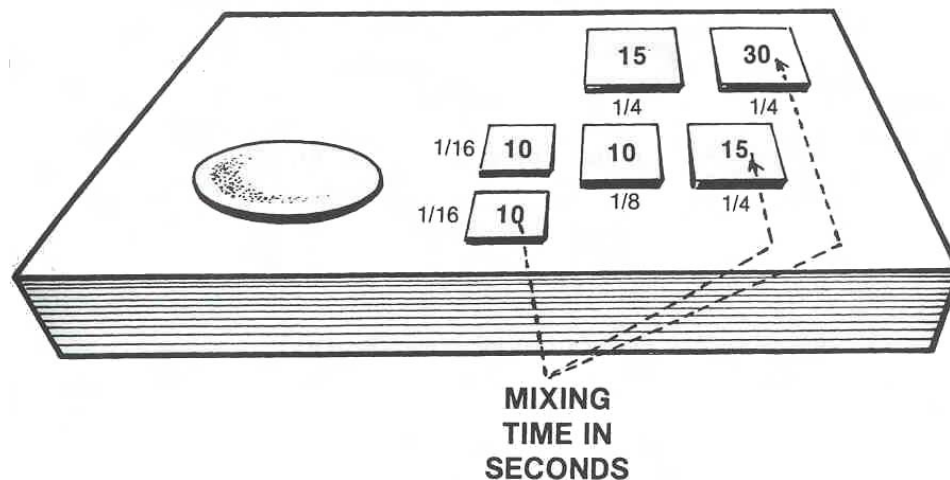

Figure 1-4. The division of powder into standard portions.

d. **Characteristics of Completed Mixes.** When a mix is ready for use, it should be similar to the consistency of melted ice cream or liquid glue (adhesive rubber). When the spatula is placed on the slab and the spatula is raised to one inch, the mix will cling to the spatula in a thin thread (peak) for one or two seconds before it breaks and then gradually spreads.

e. **Precautions.** The following precautions should be observed.

(1) Prevent loss or gain of moisture in liquid cement by keeping bottles tightly stoppered.

(2) Dispense drops only when ready to mix.

(3) Use a cool, dry glass slab (65° to 75° F).

(4) Use the same brand of powder and liquid.

(5) Add increments of powder slowly.

(6) Use the maximum amount of powder to obtain the desired consistency. (To incorporate the most powder, the material should be mixed with a moderate circular motion over a large area of the slab, turning the spatula often.)

1-15. CHARACTERISTICS OF POLYCARBOXYLATE CEMENT

a. **General.** The primary use of polycarboxylate cement is as a cementing medium of cast alloy and porcelain restorations. In addition, it can be used as a cavity liner, as a base under metallic restorations, or as a temporary restorative material.

b. **Clinical Uses.** Polycarboxylate cement is used in the same way as zinc phosphate cement, both as an intermediate base and as a cementing medium.

c. **Chemical Composition.**

(1) Powder. The composition of polycarboxylate cement powder may vary slightly depending on manufacturers. It generally contains zinc oxide, 1 to 5 percent magnesium oxide, and 10 to 40 percent aluminum oxide or other reinforcing fillers. A small percentage of fluoride may be included.

(2) Liquid. Polycarboxylate cement liquid is approximately a 40 percent aqueous solution of polyacrylic acid copolymer with other organic acids such as itaconic acid. Due to its high molecular weight, the solution is rather thick (viscous).

d. **Properties.** The properties of polycarboxylate cement are identical to those of zinc phosphate cement with one exception. Polycarboxylate cement has lower compressive strength.

e. **Setting Reactions.** Unlike zinc phosphate cement, the setting reaction of polycarboxylate cement produces little heat. This has made it a material of choice. Manipulation is simpler and trauma due to thermal shock to the pulp is reduced. The rate of setting is affected by the powder-liquid ratio, the reactivity of the zinc oxide, the particle size, the presence of additives, and the molecular weight and concentration of the polyacrylic acid. The strength can be increased by additives such as alumina and fluoride. The zinc oxide reacts with the polyacrylic acid forming a cross-linked structure of zinc polyacrylate. The set cement consists of residual zinc oxide bonded together by a gel-like matrix.

1-16. PREPARATION AND USAGE OF POLYCARBOXYLATE CEMENT

a. **Equipment.** The equipment required for mixing polycarboxylate cement consists of a nonporous, polymer paper pad, a glass mixing slab, a stainless steel spatula, and a matched set of powder and liquid (see figure 1-5).

b. **Powder and Liquid.** Dispense the powder and liquid according to manufacturer's instructions (to achieve the desired consistency). Do not predispense and allow to sit. Loss of moisture will cause the liquid to thicken.

c. **Mixing.** Mixing is done by rapidly blending the powder and the liquid for 30 seconds on a polymer paper-mixing pad. Ensure that all the powder is incorporated into the mix. If extended working time is desired, mix on a cooled glass slab.

d. **Characteristics of a Completed Mix.** The correct cementing mix is more viscous than zinc phosphate cement. Because of its composition, the cementing mix flows adequately under pressure.

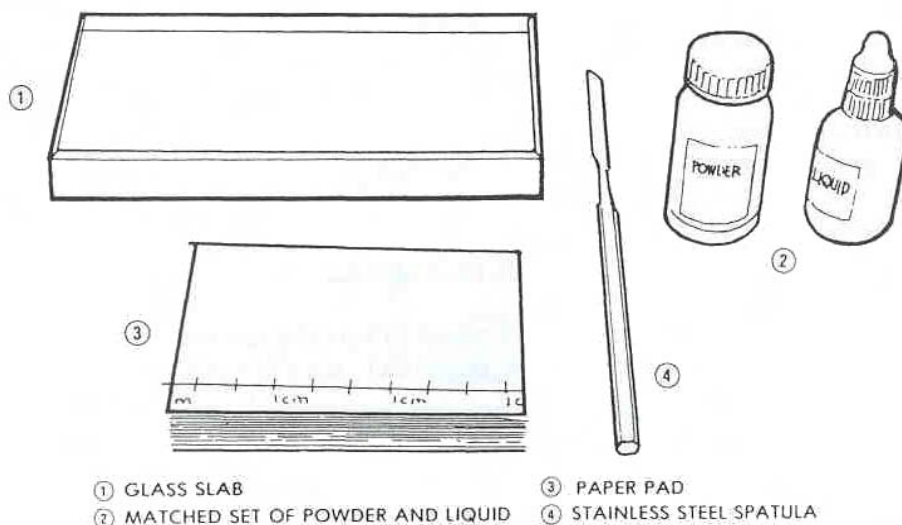

Figure 1-5. Setup for mixing polycarboxylate cement.

e. **Precautions.** The following precautions should be observed.

- (1) The interior of restorations and tooth surfaces must be free of saliva.
- (2) The mix should be used while it is still glossy, before the onset of cobwebbing.
- (3) The powder and liquid should be stored in stoppered containers under cool conditions. Loss of moisture from the liquid will lead to thickening.

1-17. CHARACTERISTICS OF GLASS IONOMER CEMENT

a. **General.** The primary use of glass ionomer cement is for permanent cementing of inlays, crowns, bridges, and/or orthodontic band/brackets. In addition, it can be used as a cavity liner and as a base.

b. **Clinical Uses.** Glass ionomer cement is used in the same way as zinc phosphate cement, both as an intermediate base and as a cementing medium.

c. **Chemical Composition.**

(1) Powder. The composition of glass ionomer cement powder may vary slightly depending on the manufacturer. It generally contains a mixture of aluminosilicate glass with dry polymaleic acid.

(2) Liquid. Glass ionomer cement liquid consists of an aqueous solution containing an accelerator. (A chemical accelerator shortens the setting time.)

d. **Properties.** Glass ionomer cement is free from phosphoric acid and has very low solubility. It adheres chemically to enamel and dentin and, readily, to wet tooth structure, leaving minimal film thickness. It is well tolerated by the pulp and remains rigid under a load, exhibiting no creep. Glass ionomer possesses high compressive strength. It releases fluoride ions to tooth structure. It is simple to proportion, mix, apply, and clean up.

e. **Setting Reactions.** For glass ionomer cement as for other dental cements, the working time is reduced if a higher powder to liquid ratio has been used. Higher temperature shortens working time and lower temperature extends working time. Glass ionomer cement should always have a glossy appearance. When the surface becomes dull, the setting reaction has started and the mix should be discarded. Exceeding the working time will result in loss of adhesion to enamel and dentin.

1-18. PREPARATION AND USAGE OF GLASS IONOMER CEMENT

a. **Equipment.** The equipment required for mixing glass ionomer cement consists of a polymer paper pad or a glass mixing slab, a stainless steel spatula, and a matched set of powder and liquid.

b. **Powder and Liquid.** The normal ratio is one level scoop of powder to two drops of liquid. For cement bases, more powder may be added to the mix to achieve a thicker consistency. For accurate proportioning, shake the powder bottle to fluff the powder. Then, fill the scoop that comes with the bottle of powder without packing the powder down. When removing the scoop from the bottle, slide it against the plastic lip in the neck of the bottle to scrape off excess powder. Be sure to hold the bottle of liquid vertically when dispensing drops of liquid so as to produce precise and uniform drops (see figure 1-6).

c. **Mixing.** All powder is incorporated into the liquid in two or three large increments. Each portion of the powder should be added to the liquid all at once. To extend the working time, mix the powder and the liquid on a cold and dry glass slab. At room temperature, the mix should be completed in about one minute (60 seconds).

d. **Characteristics of a Completed Mix.** The right consistency is obtained when the material breaks away from the spatula when it is raised one-half inch from the glass slab.

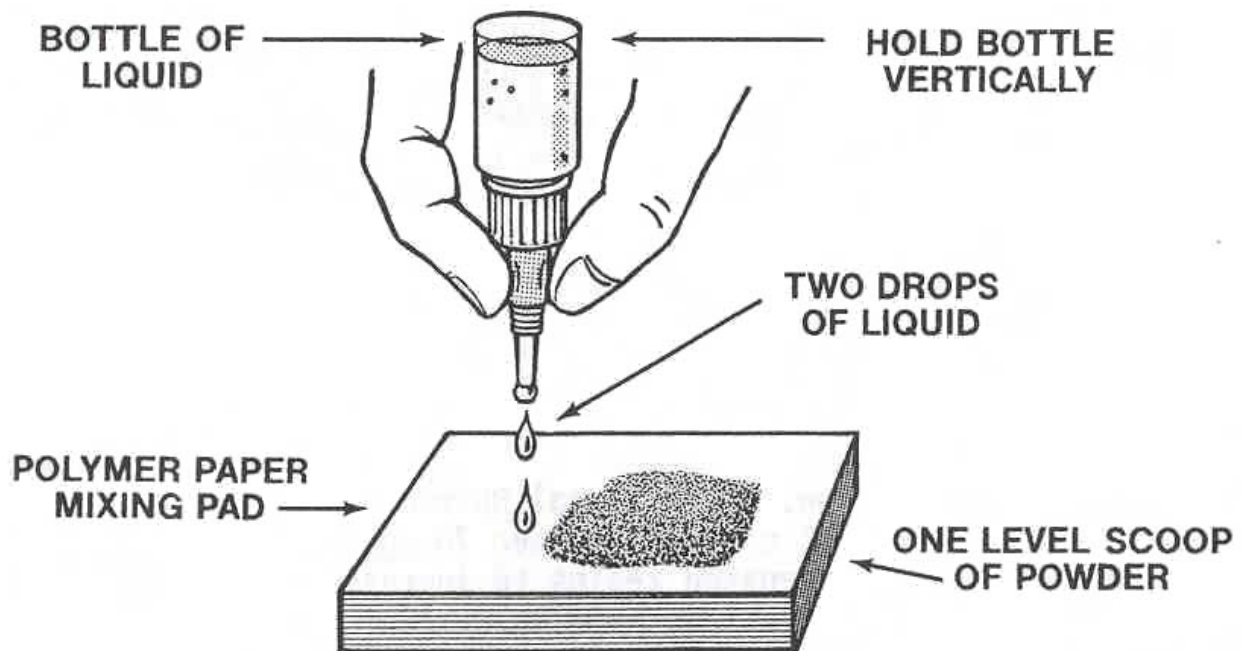

Figure 1-6. Dispensing uniform drops of glass ionomer liquid.

e. **Precautions.** The following precautions should be observed.

(1) Do not insert glass ionomer cement as a ball of material into deep cavities or where the dentin is thin or where there is danger of pulpal involvement. In these cases, set a calcium hydroxide liner in place before inserting the glass ionomer cement.

(2) There may be an allergic reaction to the glass ionomer cement in some cases.

(3) Upon contact with eyes, the powder may cause irritation due to foreign body reaction. Similarly, ingestion of the liquid may cause local irritation.

(4) All enamel, dentin, and metal surfaces must be clean and dry before use of glass ionomer cement.

(5) Do not overfill the crown. Brush a thin coat of glass ionomer cement on the internal crown surface and abutments.

(6) Bottles of liquid or powder should be tightly closed after use to prevent moisture contamination of the powder and evaporation of the liquid.

1-19. CHARACTERISTICS OF ZINC OXIDE AND EUGENOL

a. **General.** This material is used for many dental purposes ranging from temporary restorative material to pulp capping. The material is composed of a powder that is basically zinc oxide and a liquid that is called eugenol. Cavitec, a commercial preparation, is an example of zinc oxide and eugenol. Generally, however, a generic form is used in military dental clinics.

b. **Chemical Composition.** By National Bureau of Standards specifications, the powder must contain between 70 and 100 percent zinc oxide. The manufacturer may add hydrogenated resins to increase strength and zinc acetate to hasten the set. Eugenol is usually derived from oil of cloves. The oil of cloves contains more eugenol (82 percent) than do the oils of bay, orange, or cinnamon. Eugenol is an obtundent (pain-relieving agent). It is a clear liquid that gradually changes to amber when exposed to light.

c. **Physical Properties.** This material relieves pain, makes tissue less sensitive to pain, is slightly antiseptic, and is low in thermal conductivity. It provides a good marginal seal when placed in tooth cavities. The crushing strength (compression strength) of pure zinc oxide and eugenol is about 2,000 psi, which is low in comparison to other cements. The addition of hydrogenated resin increases the crushing strength to 5,000 psi.

1-20. CLINICAL USES OF ZINC OXIDE AND EUGENOL

a. **Treatment Restoration.** The most frequent use of zinc oxide and eugenol is as a treatment restoration. It helps prevent pulpal irritation when set in place for treatment of fractured teeth, lost restorations, advanced caries, or pulpitis. This dental material also exerts a palliative (affording relief, but not cure) effect on the pulp.

b. **Temporary Cementing Medium.** Zinc oxide and eugenol is used as a temporary cementing medium for crowns, inlays, and fixed partial dentures. These fixed appliances may later be permanently cemented with zinc phosphate cement.

c. **Intermediate Base.** Zinc oxide and eugenol is used as an intermediate base. This material provides insulation between metallic restorations and vital tooth structure. Because of the low crushing strength, its use is sometimes contraindicated. The dental officer will often require that a zinc phosphate cement base be placed over the zinc oxide and eugenol to better support a metallic restoration.

d. **Pulp Capping.** This material is used in pulp capping for near and direct exposures of the pulp, but this use is declining. Calcium hydroxide is now preferred for pulp capping.

e. **Surgical Packing or Dressing.** This material is used as a surgical packing or dressing after certain periodontal surgical procedures. An example of this is the surgical dressing applied and adapted over the gingival area after a gingivectomy. This dressing protects the area and makes the tissue less sensitive.

Continue with Exercises

EXERCISES, LESSON 1

INSTRUCTIONS: Answer the following exercises by marking the lettered response that best answers the question or best completes the incomplete or by writing the answer in the space provided.

After you have completed all the exercises, turn to "Solutions to Exercises" at the end of the lesson and check your answers. For each incorrect answer, reread the material referenced following the answer.

1. List factors that make demands upon restorative dental materials.
 - a. The corrosive nature of _____.
 - b. The _____ and _____ of tooth structure with changes in temperature.
 - c. The stress of _____ forces (grinding and chewing).
 - d. Compatibility with _____ tissues.
 - e. Where visible, materials must be _____ pleasing.

2. Select the grain size in metals that gives the most desirable properties.
 - a. Small grains.
 - b. Large grains.

3. In cast metal, the grains are:
 - a. Elongated.
 - b. Flattened.

4. Match the term in Column I to the definition in Column II. Write your answer in the space provided.

<u>COLUMN I</u>		<u>COLUMN II</u>	
(1)	___ Hardness	a.	Permits a metal to be shaped into a thin sheet or plate
(2)	___ Ductility	b.	Allows a metal to deform temporarily
(3)	___ Malleability	c.	Returns a metal to its original shape
(4)	___ Flexibility	d.	Resistance of a metal to indentation or scratching
(5)	___ Elasticity	e.	Capacity of a metal to be stretched without fracturing

5. Match the term in Column I to the definition in Column II. Write your answer in the space provided.

<u>COLUMN I</u>		<u>COLUMN II</u>	
(1)	___ Fatigue	a.	Ability to transmit heat or cold
(2)	___ Crushing strength.	b.	Resistance to fracture under compression
(3)	___ Thermal conductivity.	c.	Fracture point after repeated stressing

6. Match the term in Column I to the definition in Column II. Write your answer in the space provided.

COLUMN I

COLUMN II

- | | | | |
|---------|------------------|----|--|
| (1) ___ | Cold working | a. | Heat softening treatment |
| (2) ___ | Strain hardening | b. | Heat hardening treatment |
| (3) ___ | Annealing | c. | Changing the shapes of metal at room temperature. |
| (4) ___ | Tempering | d. | Metal becomes stiffer after force is applied, to the point of fracture |

7. Select the metallurgical process that restores properties to metals that are decreased by cold working and annealing.
- a. Cold working.
 - b. Softening heat treatment.
 - c. Strain hardening.
 - d. Hardening heat treatment.
8. Select the metal included in dental silver alloy which has a specified percentage range of from 6 to 13 percent.
- a. Mercury.
 - b. Silver.
 - c. Tin.
 - d. Zinc.
 - e. Copper.

9. The metallic element in dental amalgam that is silver-white, liquid at room temperature, and poisonous is _____.
10. Dental amalgam is a:
- Solid mixture of silver, tin, copper, and zinc.
 - Specially prepared silver alloy combined with mercury.
11. Which of the following ingredients of dental amalgam imparts strength, durability, and color, decreases the setting time and flow, and gives desirable setting expansion?
- Mercury.
 - Copper.
 - Silver.
 - Zinc.
 - Tin.
12. Which of the following ingredients of an amalgam restoration increases workability and unites with oxygen to produce a clean amalgam?
- Tin.
 - Zinc.
 - Silver.
 - Copper.
 - Mercury.

13. The most important physical properties of amalgam are:
- Flow and _____.
 - _____ change.
 - _____ strength.
14. At 50 percent mercury content, the compression strength of amalgam is:
- 30,000 psi.
 - 52,000 psi.
 - 100,000 psi.
15. Which of the following is an advantage of amalgam?
- As it ages, corrosion products form along the interface of the restoration and the tooth.
 - It conducts heat or cold readily.
 - The color does not match the color of the teeth.
 - It will tarnish with time.
16. Select the result that is NOT caused by undertrituration.
- Lengthened setting time
 - Increased expansion.
 - Weakened amalgam.
 - Increased shrinkage.

17. Complete information related to the usage of amalgam.
- The amalgam is taken from the capsule and placed in an _____
 - The process of packing an amalgam mix into a cavity preparation is called _____.
 - Sufficient packing pressure is necessary to prevent _____ in the restoration.
 - Immediately after condensation, _____ can be started with sharp instruments.
18. List four adverse effects of moisture contamination.
- Excessive _____ of amalgam.
 - _____ pain.
 - Lowered _____.
 - _____ formation on the _____ of the amalgam.
19. What should you do with capsules in poor condition or cracked capsules?
- Store them in a closed container in a fireproof area.
 - Cleanse them with a water coolant.
 - Discard them IAW SOP.
20. There must be no _____ in the part of the clinic where mercury or amalgam are used.
- Carpeting.
 - Storage of materials.
 - Source of heat.

21. How often must amalgamators be cleaned?
- Every day.
 - Once a week.
 - Once a month.
22. List the four types of dental cement discussed in the lesson.
- _____ cement.
 - _____ cement.
 - _____ cement.
 - _____ and _____ cement.
23. List two ways that zinc phosphate is used.
- As an _____
 - As a _____.
24. The primary ingredients of zinc phosphate cement powder are:
- _____.
 - _____.
25. The ratio of the ingredients of zinc phosphate cement liquid is as follows.
- Two parts of _____.
 - One part of _____.

26. Zinc phosphate cement liquid should NOT be discarded when:
- The liquid has been left unstoppered for a long time.
 - The liquid is discolored.
 - The liquid is down to the last 30 percent in the bottle.
27. List advantages of zinc phosphate as a cementing medium.
- _____ appearance.
 - Speed and _____ of usage.
 - Sufficient flow to form a thin _____ for cementing.
 - Low _____ conductivity beneath a metallic restoration.
28. List disadvantages of zinc phosphate as a cementing medium.
- _____ crushing strength.
 - _____ solubility in mouth fluids.
 - _____ material (not suitable for visible surfaces).
29. The compression strength of zinc phosphate cement is between:
- 12,000 and 19,000 psi.
 - 21,000 and 29,000 psi.
 - 30,000 and 52,000 psi.
30. Zinc phosphate cement will take longer to harden when:
- Less powder is used.
 - More powder is used.
 - Powder in equal amounts is used.

31. List four actions to maintain and prolong the normal setting time for zinc phosphate cement.
- Keep (or lower) the temperature to between _____ and _____ F.
 - Blend the powder _____.
 - Mix the powder over a _____ of the cool slab.
 - Use a _____ mixing time.
32. When preparing a mix of zinc phosphate cement, the powder is divided and subdivided into portions. Of the total number of portions to be mixed, how many are sixteenth portions?
- Six.
 - Four.
 - Two.
33. When mixing zinc phosphate cement, how is the liquid dispensed?
- With a special dropper supplied by the manufacturer.
 - With a generic dropper supplied by the dental clinic.
34. List the segments and time rules for spatulation.
- Spatulate the first three segments for about _____ seconds.
 - Spatulate the next two segments for about _____ seconds.
 - Spatulate the final segment for _____ to _____ seconds.

35. When the zinc phosphate cement mix is ready for use, it should be similar in consistency to:
- Putty.
 - Skim milk.
 - Thick cream.
 - Melted ice cream.
36. Describe what happens after the spatula is placed on the slab when mixing zinc phosphate cement.
- The spatula is raised _____ inch(es).
 - The mix clings in a _____ (a peak).
 - The mix holds for _____ or _____ seconds before it breaks and gradually spreads.
37. List the uses of polycarboxylate cement.
- As a cementing medium of _____.
 - As a cementing medium of _____.
 - As a _____.
 - As a base under _____ restorations.
 - As a _____ restorative material.
38. Polycarboxylate cement powder contains:
- Zinc oxide.
 - Magnesium oxide, _____ to _____ percent.
 - Aluminum oxide, _____ to _____ percent.
 - Sometimes, a small percentage of _____.

39. Polycarboxylate cement liquid is rather thick. It has:
- Low molecular weight.
 - High molecular weight.
40. List advantages of polycarboxylate cement over zinc phosphate cement.
- It is easier to _____.
 - There is less _____ due to thermal shock to the pulp.
41. Mixing of polycarboxylate cement is done by rapidly blending the powder and the liquid for _____ seconds on a nonporous, polymer paper mixing pad.
42. List three precautions concerning polycarboxylate cement.
- The mix should be used while it is still _____, before the onset of _____.
 - _____ containers should be used to store the powder and the liquid. They should be stored in a _____ place.
 - The interior of restorations and tooth surfaces must be free of _____.
43. The primary use of glass ionomer cement is for permanent cementing of:
- _____.
 - _____.
 - _____.
 - Orthodontic _____.

44. The glass ionomer cement powder contains a mixture of _____ glass with dry _____ acid.
45. List important properties of glass ionomer cement.
- It adheres chemically to _____ and _____ and, also, to _____ tooth structure.
 - It is well tolerated by the dental _____.
 - It remains _____ under a load.
 - It possesses high _____ strength.
 - It is simple to proportion, to _____, to _____, and to _____.
46. Describe the appearance of glass ionomer cement.
- It should always have a _____ appearance.
 - When the surface becomes _____, the setting reaction has started. The mix should be discarded.
47. For glass ionomer cement, why is it important never to exceed the working time? Exceeding the working time will result in _____ of _____ to enamel and dentin.
48. The normal ratio of powder to liquid for glass ionomer cement is:
- One level scoop of powder to two drops of liquid.
 - Two drops of liquid to one heaping scoop of powder.

49. In order to produce precise and uniform drops from the liquid bottle for glass ionomer cement, what do you have to do?

_____ it _____

50. Complete information related to mixing glass ionomer cement.

a. Powder is incorporated into the liquid in _____ or _____ large increments.

b. Each portion of the powder is added to the liquid _____

c. The mix should be completed in about _____ seconds, at room temperature.

51. For glass ionomer cement, you know that the right consistency is obtained when the spatula is raised from the glass slab and the material breaks away at:

a. 1/4 inch.

b. 1/2 inch.

c. 1 inch.

d. 1 1/2 inches.

52. Should glass ionomer cement be inserted close to the pulp?

a. Yes.

b. No.

53. Is it a requirement to set in place a calcium hydroxide liner before inserting glass ionomer cement where the dentin is thin, in deep cavities, or where the pulp is involved.?

a. Yes.

b. No.

54. List potential hazards of glass ionomer cement.
- Some people may have an _____ to glass ionomer cement.
 - Powder in the _____ may cause _____ due to foreign body reaction.
 - If you _____ some of liquid that is used to mix glass ionomer cement, you will probably get some localized irritation.
55. It is known that glass ionomer cement adheres to wet tooth structure. Enamel and dentin _____ clean and dry before application.
- Have to be.
 - Don't have to be.
56. List the clinical uses of zinc oxide and eugenol.
- For treatment _____.
 - As a _____ cementing medium.
 - As an intermediate _____.
 - For _____ capping.
 - As a _____ or dressing.
57. According to NBS specifications, what is the percentage of zinc oxide powder required for zinc oxide and eugenol cement?
- 70 to 100 percent.
 - 70 to 90 percent.
 - 60 to 90 percent.
 - 60 to 80 percent.

58. Oil of _____ contains 82 percent eugenol.
- a. Cinnamon.
 - b. Oranges.
 - c. Cloves.
 - d. Bay.
59. Which dental cement is more likely to be used when there is pulpitis, advanced caries, or fractured teeth?
- a. Polycarboxylate.
 - b. Zinc oxide and eugenol.
 - c. Glass ionomer.
 - d. Zinc phosphate.
60. Select the dental cement with the lower crushing strength that may be used to provide insulation between metallic restorations and vital tooth structures. (It may be used alone or in combination with another dental cement.)
- a. Zinc phosphate.
 - b. Polycarboxylate.
 - c. Glass ionomer.
 - d. Zinc oxide and eugenol.

Check Your Answers on Next Page

SOLUTIONS TO EXERCISES, LESSON 1

1. a. saliva
b. expansion; contraction
c. masticatory
d. living
e. esthetically (para 1-2)
2. a (para 1-3f(1))
3. b (para 1-3f(2))
4. (1) d
(2) e
(3) a
(4) b
(5) c (para 1-3)
5. (1) c
(2) b
(3) a (para 1-3)
6. (1) c
(2) d
(3) a
(4) b (para 1-4)
7. d (para 1-4d)
8. e (para 1-5c(3), figure 1-1)
9. mercury (para 1-5b(3))
10. b (para 1-5b(2))
11. c (para 1-5c(5); Table 1-1)
12. b (para 1-5c(5); Table 1-1)
13. a. creep
b. Dimensional
c. Compression (para 1-5d)
14. b (para 1-5d(3))

15. a (para 1-6a)
16. d (para 1-7b)
17. a. amalgam cup
b. condensation
c. voids
d. carving (paras 1-7c, d)
18. a. expansion
b. Postoperative
c. crushing strength
d. Blister; surface (para 1-8a(1))
19. c (para 1-9b(4))
20. a (para 1-9b(14))
21. b (para 1-9b(13))
22. a. Zinc phosphate
b. Polycarboxylate
c. Glass ionomer
d. Zinc oxide and eugenol (para 1-10)
23. a. intermediate base.
b. cementing medium. (para 1-11b)
24. a. Zinc oxide.
b. Magnesium oxide. (para 1-11c(1))
25. a. phosphoric acid.
b. water. (para 1-11c(2))
26. c (para 1-11c(2))
27. a. Inconspicuous
b. ease
c. layer
d. thermal (para 1-12a)

28.
 - a. Low
 - b. Slight
 - c. Opaque (para 1-12b)
29. a para 1-12b(1))
30. a (para 1-13b)
31.
 - a. 65° and 75°.
 - b. slowly.
 - c. large area
 - d. longer (para 1-13c)
32. c (para 1-14b, figure 1-4)
33. a (para 1-14b)
34.
 - a. 15
 - b. 20
 - c. 30 to 35 (para 1-14c)
35. d (para 1-14d)
36.
 - a. one inch
 - b. thin thread
 - c. one or two (para 1-14d)
37.
 - a. cast alloy
 - b. porcelain restorations
 - c. cavity liner
 - d. metallic
 - e. temporary (para 1-15a)
38.
 - b. 1 to 5
 - c. 10 to 40
 - d. fluoride (para 1-15c(1))
39. b (para 1-15c(2))
40.
 - a. manipulate
 - b. trauma (para 1-15e)
41. 30 (para 1-16c)

- 42.
 - a. glossy; cobwebbing
 - b. Stopped; cool
 - c. saliva (para 1-16e)

- 43.
 - a. Inlays.
 - b. Crowns.
 - c. Bridges.
 - d. band/brackets. (para 1-17a)

- 44. aluminosilicate; polymaleic (para 1-17c(1))

- 45.
 - a. enamel and dentin; wet
 - b. pulp
 - c. rigid
 - d. compressive
 - e. mix; apply; clean up (para 1-17d)

- 46.
 - a. glossy
 - b. dull (para 1-17e)

- 47. loss of adhesion (para 1-17e)

- 48. a (para 1-18b)

- 49. Hold it vertically. (para 1-18b)

- 50.
 - a. 2 or 3
 - b. all at once.
 - c. 60 (para 1-18c)

- 51. b (para 1-18d)

- 52. b (para 1-18e(1))

- 53. a (para 1-18e(1))

- 54.
 - a. allergic reaction
 - b. eyes; irritation
 - c. drink (OR ingest) (para 1-18e(2)(3))

- 55. a (para 1-18e(4))

- 56. a. restoration
 - b. temporary
 - c. base.
 - d. pulp
 - e. surgical packing (para 1-20)
-
- 57. a (para 1-19b)
-
- 58. c (para 1-19b)
-
- 59. b (para 1-20a)
-
- 60. d (para 1-20c)

End of Lesson 1

LESSON ASSIGNMENT

LESSON 2

Dental Resins, Miscellaneous Dental Materials, and Dental Gold/Alloys.

TEXT ASSIGNMENT

Paragraphs 2-1 through 2-20.

LESSON OBJECTIVES

After completing this lesson, you should be able to:

- 2-1. Identify the characteristics and uses of composite resins.
- 2-2. Identify the characteristics of intermediate restorative material (IRM).
- 2-3. Identify the uses of root canal filling materials, calcium hydroxide, and cavity lining varnish.
- 2-4. Identify basic information concerning dental porcelain.
- 2-5. Identify dental polishing materials and their uses.
- 2-6. Identify the characteristics of dental gold alloy.
- 2-7. Identify the types of gold alloys used in dentistry.

SUGGESTION

After studying the assignment, complete the exercises at the end of this lesson. These exercises will help you to achieve the lesson objectives.

LESSON 2

DENTAL RESINS, MISCELLANEOUS DENTAL MATERIALS, AND DENTAL GOLD/ALLOYS

Section I. DENTAL RESINS FOR RESTORATIVE DENTISTRY

2-1. GENERAL

Because of its esthetic (term used for an artistically pleasing appearance) properties, resin can be used for the reproduction of lost tooth structure. The dental officer prepares the cavity in the tooth in the usual manner, inserts the plastic mixture directly into the cavity, and allows it to polymerize at mouth temperature. These materials are often referred to as direct-filling resins. Certain shortcomings in the physical properties of resins restrict their use when esthetics, such as the restoration of anterior teeth, are the principal concern. Although not as strong as amalgams, resins are designed to meet the needs of a specific area of a tooth or mouth. The most commonly used and most widely accepted is composite resin.

2-2. COMPOSITE RESINS

a. **Clinical Use.** Composite resins are the most commonly used material for all permanent anterior restorations and are increasingly being used in posterior restorations. These resins make excellent restorative materials because of their good resistance to wear and their excellent esthetics. Silar, Adaptic, and Concise are some of the trade names of composite resins.

b. **Chemical Composition.** Composite resins are composed of universal paste with filler and catalyst paste. All composite resins use quartz (a hard rock-forming mineral) as a filler.

c. **Properties.** Composite resins have excellent esthetic properties. In fact, the universal paste will match 89 percent of all tooth shades. Tints are available for the other 11 percent. Composite resins have good resistance to wear because of the filler. They also have an acceptable compressive strength of 35,000 psi. Thermal expansion is at a minimum. (The manufacturer claims that the thermal expansion is close to the normal expansion of tooth structure.) Solubility and shrinkage are low. Refrigeration of the composite resin is required to prevent deterioration.

d. **Mixing.** As with unfilled resins, the manufacturer's directions should be followed when mixing composites. There are several types available and each requires a specific mixing procedure. To mix the two-paste system, equal parts of the pastes are mixed with a folding motion to a uniform color within 20 to 30 seconds. The average working time from start of mixing to insertion of product is 1 1/2 to 2 minutes. It is important to avoid cross-contamination between jars of universal and catalyst pastes. The double-ended spatula provided with the kit has differently shaped ends, one clearly labeled "uni" and the other labeled "cat." Improper mixing could cause failure of the restoration. Also, improper ratio of pastes will decrease the strength as will insufficient spatulation. Use of a metal spatula will result in discoloration of the material, giving poor esthetics. However, the single paste, lightproof syringe is the most common form used. Light-cured resins do not require mixing, but are used directly from the syringe. This single-paste contains both the photoinitiator and the amine activator and requires the use of a curing light to polymerize. The exact curing time depends on the manufacturer's instructions (most often 20 to 60 seconds) and the thickness and size of the restoration.

2-3. ACID ETCH TECHNIQUE

Cavities requiring added retention (to hold firmly) are treated with an acid etching technique. This technique improves the seal of the composite resin to the cavity wall. The enamel adjacent to the margins of the preparation is slightly decalcified with a 40 to 50 percent phosphoric acid solution. This etched enamel enhances the mechanical retention of the composite resin. In addition, the acid etch technique is used to splint unstable teeth to adjacent teeth. The acid is left on the cut tooth structure only 15 seconds, in accordance with the directions for one common commercial brand. The area is then flushed with water for a minimum of 30 seconds to remove the decalcified material. Etched tooth structure will have a chalky appearance.

2-4. PIT AND FISSURE SEALANTS

Pit and fissure sealants are similar to the unfilled resin portion of acid etch composite filling materials. This plastic resin is used as a prophylactic seal of occlusal pits and fissures. The purpose is to prevent carious destruction of tooth structure. The sealant is used when there is a deep occlusal pit or fossa or a lingual pit, when there is an intact occlusal surface with a carious or restored contra lateral tooth surface, and where there is high carious activity, poor oral hygiene, or newly erupted posterior teeth.

2-5. INTERMEDIATE RESTORATIVE MATERIAL

Intermediate restorative material (IRM) is a zinc oxide and eugenol cement that has been reinforced for increased strength. It is used as an intermediate base beneath a metallic restoration and also as a temporary restoration.

a. **Composition.**

(1) Powder. The powder is composed of 80 percent zinc oxide and 20 percent polymethyl methacrylate.

(2) Liquid. The liquid is 99 percent eugenol and 1 percent acetic acid.

b. **Dispensing.** The first step in dispensing IRM is to fluff the powder for uniform density. The measuring scoop is then filled, but not packed, with powder and leveled with the spatula. The powder is then placed on the mixing pad. Finally, one drop of liquid is added for each level scoop of powder (at a 1 to 1 ratio). After using the liquid, immediately recap to prevent evaporation and contamination.

c. **Mixing.** Spatulate quickly with a stainless steel spatula, combining half the powder with all the liquid. Add the remaining powder in 2 or 3 increments and spatulate thoroughly. The mix will be stiff and should be stropped (whipped vigorously) each time with the spatula for 5 to 10 seconds. This type of mixing results in a smooth and adaptable working consistency. Mixing the IRM should be completed in approximately 1 minute (60 seconds).

Section II. MISCELLANEOUS DENTAL MATERIALS

2-6. CALCIUM HYDROXIDE

Calcium hydroxide is used in operative procedures such as pulp capping (protection for an exposed or nearly exposed pulp). It is available in premixed commercial preparations ready for immediate use. Because of its low crushing strength, calcium hydroxide alone is not used as an intermediate base. It is usually covered with zinc phosphate cement or zinc oxide and eugenol cement. Dycal, a commercial preparation, is an example of calcium hydroxide.

2-7. ROOT CANAL FILLING MATERIALS

Root canal filling materials consist of tapered gutta-percha or silver points in standard sizes that match the size of the files used. The points are cemented in place with root canal sealer that is usually a zinc oxide and eugenol preparation. Root canal filling materials are used to fill previously prepared root canals. They are a part of root canal, or endodontic, therapy.

2-8. GUTTA-PERCHA POINTS

a. **General.** Gutta-percha points are made from the refined, coagulated, milky exudate of trees in the Malay peninsula. Gutta-percha is pink or gray in color. It is softened by heat and is easily molded. When cool, gutta-percha maintains its shape. Gutta-percha points are used as a root canal filling material.

b. Advantages.

- (1) They have a high thermal expansion.
- (2) They do not shrink unless used with solvent.
- (3) They are radiopaque, conduct heat poorly, and are easy to remove from the root canal.
- (4) They may be kept sterile in antiseptic solution, are impervious to moisture, and are bacteriostatic (prevent the growth or multiplication of bacteria).

c. Disadvantages.

- (1) They shrink when used with a solvent.
- (2) They are not always easy to introduce into the root canal.

2-9. DENTAL PORCELAIN

a. General. Dental porcelain is manufactured as a powder. When it is heated to a very high temperature in a special oven, it fuses into a homogeneous mass. The heating process is called baking. Upon cooling, the mass is hard and dense. The material is made in a variety of shades to closely match most tooth colors. Baked porcelain has a translucency similar to that of dental enamel, so that porcelain crowns, pontics, and inlays of highly pleasing appearance can be made. Ingredients of porcelain include feldspar, kaolin, silica in the form of quartz, materials which act as fluxes to lower the fusion point, metallic oxide, and binders. Porcelains are classified into high-, medium-, and low-fusing groups, depending upon the temperature at which fusion takes place.

b. High-Fusing Porcelains. High-fusing porcelains fuse at 2,400° Fahrenheit or over. They are used for the fabrication of full porcelain crowns (jacket crowns).

c. Medium-Fusing Porcelains. Medium-fusing porcelains fuse between 2,000° and 2,400° Fahrenheit. They are used in the fabrication of inlays, crowns, facings, and pontics. A pontic is the portion of a fixed partial denture, which replaces a missing tooth.

d. Low-Fusing Porcelains. Low-fusing porcelains fuse between 1,600° and 2,000° Fahrenheit. They are used primarily to correct or modify the contours of previously baked high- or medium-fusing porcelain restorations.

2-10. POLISHING MATERIALS

a. **Tin Oxide.** Tin oxide is used in polishing teeth and metal restorations. Tin oxide is a fine, white powder that is made into a paste by adding water or glycerin.

b. **Pumice.** Pumice is used as an abrasive and polishing agent for acrylic resins, amalgams, and gold. It consists mainly of complex silicates of aluminum, potassium, and sodium. Two grades--flour of pumice and coarse pumice--are listed in the Federal Supply Catalog.

c. **Chalk (Whiting).** Chalk is used for polishing acrylic resins and metals. It is composed primarily of calcium carbonate.

d. **Tripoli.** Tripoli is usually used for polishing gold and other metals. It is made from certain porous rocks.

e. **Rouge (Jeweler's).** Rouge is used for polishing gold and is composed of iron oxide. It is usually in cake or stick form.

f. **Zirconium Silicate.** Zirconium silicate is used for cleaning and polishing teeth. It may be mixed with water or with fluoride solution for caries prevention treatment. For full effectiveness, instructions must be followed exactly to obtain the proper proportions of powder to liquid.

Section III. DENTAL GOLD AND GOLD ALLOYS

2-11. GENERAL

Gold, the most noble of metals, seldom tarnishes or corrodes in the oral cavity. Because of the softness of pure gold, it is not indicated for use in the mouth except in the form of gold foil. Gold is frequently used in combination with other metals to produce alloys that can be used to fabricate various types of dental restorations where metal is indicated. The basic types of gold alloys used in dentistry are casting gold, gold solder, wrought gold, and gold plate. The principal metals used to combine with gold to form the alloys are silver, copper, platinum, palladium, and zinc.

2-12. ADMINISTRATIVE CONTROL

Controlled items subject to strict accountability and safeguarding are gold solder, platinum foil, and gold, silver, and chromium alloys. In addition, scraps from these controlled items and from amalgam are also subject to the same controls. These items are controlled by delegated members of the dental facility; however, all members of the dental care system must be aware of safeguarding precious metals, collecting precious and semiprecious scrap, and accounting for receipt, use, and turn-in of these items. If dental precious metal appliances, such as gold crowns and gold bridges, are retrieved from a patient, they are turned in as precious metal scrap subject to accounting controls.

2-13. FINENESS, CARAT, AND WEIGHING

The amount of gold in a gold alloy may be rated in terms of fineness or carat. Fineness is determined by the parts per thousand of pure gold contained in the alloy. In terms of fineness, pure gold is 1,000 fine and an alloy with three-fourths pure gold is 750 fine. In the carat system of rating, the carat refers to the parts of gold determined by dividing the substance into 24 units and then counting the number of units of gold. Thus, a 24-carat substance would be pure gold and a 12-carat alloy would be one-half gold. In weighing precious metals like gold and platinum, the troy system of weight is used. In this system, the basic units of measurement of alloy quantity are grains, pennyweights, and ounces. Gold alloys are recorded and issued by the troy system as indicated in Table 2-1.

24 grains (gr)	=	1 pennyweight (dwt)
20 pennyweight (dwt)	=	1 ounce (oz)
12 ounces (oz)	=	1 pound (lb)
The conversion formula for carat to fineness is:		
$\frac{\text{carat}}{24}$	=	$\frac{\text{fineness}}{1000}$

Table 2-1. Troy system of weight.

2-14. ANNEALING AND TEMPERING

Through the use of controlled heat and rate of cooling, gold alloys can be annealed (softened) or tempered (hardened). Gold alloys are hardened by slow cooling. Rapid cooling from a high temperature will soften a gold alloy. Rapid cooling is done by quenching the heated gold alloy in tap water.

2-15. GOLD FOIL

Gold foil is a restorative material used in the pure state. It is used most often on facial surfaces, proximal surfaces of anterior teeth, and occlusal surfaces of posterior teeth. Its chief disadvantages are color, high thermal conductivity, and difficulty in manipulation. Gold foil is available in either adhesive or nonadhesive form. To prevent pellets of adhesive foil from sticking together before use, their surfaces are treated with moisture or gas residues. When ready for use, the moisture and gas residues are vaporized by heating.

2-16. CASTING GOLD ALLOY

a. **General.** Restorations made with gold foil do not exhibit as much overall strength and resilience as do restorations made with gold alloys. Casting gold alloy is used in the fabrication of various types and classes of restorations. It is alloyed and made into ingots suitable for melting and casting into molds for the restorations.

b. Four Types of Casting Gold Alloys.

- (1) Soft. For inlays not subjected to stress.
- (2) Medium. For ordinary inlay work.
- (3) Hard. For full crowns, three-quarter crowns, and retainers.
- (4) Extra hard. For saddles, clasps, and one-piece cast partial dentures.

c. **Usage.** Casting gold alloys can be whitened (white gold) by adding palladium, platinum, or silver. Casting gold alloy is also used for crowns and abutments requiring great strength and hardness.

2-17. GOLD ALLOY SOLDER

Gold alloy solder is used for joining the parts of fixed partial dentures, for building up or forming restorations, and for gold repairs. Soldering is the process of joining metals by means of a solder or a lower fusing metal.

2-18. WROUGHT GOLD

Wrought gold is used for the construction of clasps and orthodontic appliances.

2-19. GOLD PLATE

Gold plate is used less often than casting gold alloy, gold alloy solder, or wrought gold. It is used in the fabrication of some types of crowns and often used in repair procedures.

2-20. NONPRECIOUS ALLOYS

Nonprecious alloys were developed as an alternative to the expensive precious metal alloys. They are used primarily in the fabrication of ceramometal restorations. These alloys are composed chiefly of chromium, nickel, and molybdenum.

Continue with Exercises

EXERCISES, LESSON 2

INSTRUCTIONS: Answer the following exercises by marking the lettered response that best answers the question or best completes the incomplete or by writing the answer in the space provided.

After you have completed all the exercises, turn to "Solutions to Exercises" at the end of the lesson and check your answers.

1. Silar is an example of a commercial product used in restorative dentistry. It is a/an:
 - a. Acrylic resin.
 - b. Zinc oxide and eugenol.
 - c. Calcium hydroxide.
 - d. Composite resin.

2. Describe composite resins.
 - a. _____ paste with filler (in a jar).
 - b. _____ paste (in a jar).
 - c. A filler, usually _____.

3. Complete information related to properties of composite resins.
 - a. The universal paste will match _____ percent of all tooth shades.
 - b. The compressive strength is _____ psi.
 - c. They have low _____ and _____.
 - d. _____ is required.

4. Complete information related to the mixing of composite resins.
 - a. In the two-paste system, _____ parts of the paste are mixed to a uniform color.
 - b. Mixing is done within _____ to _____ seconds.
 - c. _____ spatulation will decrease the strength of the mixture.

5. Describe why a double-ended, nonmetal spatula is used to mix composite resin.
 - a. To avoid cross-contamination between jars of paste, each end of the spatula is clearly labeled _____ or _____.
 - b. Use of a metal spatula will result in _____ of the material.

6. Describe the acid etch technique.
 - a. The use of this technique improves the _____ of the composite resin to the cavity wall, thus strengthening it.
 - b. _____ to _____ percent phosphoric acid is applied to the margins of the cavity.
 - c. The acid is left on the cut tooth surface for _____ seconds and then flushed with water for _____ seconds.
 - d. Etched tooth structure will have a _____ appearance.

7. Complete information related to intermediate restorative material (IRM).
 - a. The powder consists of 80 percent _____ and 20 percent _____ methacrylate (also used for acrylic resin).
 - b. The liquid is 99 percent _____.
 - c. _____ drop of liquid is added to _____ level scoop of powder.
 - d. When mixing, the mix should be _____ with the spatula for _____ to _____ seconds.
 - e. It takes approximately _____ seconds to complete mixing IRM.

8. Dycal, a commercial product, is an example of:
 - a. Zinc oxide and eugenol.
 - b. IRM.
 - c. Composite resin.
 - d. Pulp capping material.

9. Is it usual to cover a layer of calcium hydroxide with zinc phosphate cement or zinc oxide and eugenol cement?
 - a. Yes.
 - b. No.

10. Which of the following does not pertain to Gutta-percha points?
 - a. High thermal expansion.
 - b. Radiopaque.
 - c. Radiolucent.
 - d. Conduct heat poorly.

11. Which of the following is more rapidly softened by heat and more easily molded?
- Calcium hydroxide.
 - Composite.
 - Gutta-percha root canal points.
 - Pit and fissure sealants.
12. Which of the following is manufactured as a powder?
- Pit and fissure sealants.
 - Dental porcelain.
 - Gutta-percha root canal points.
 - Polishing materials.
13. The ingredients of porcelain includes all of the following EXCEPT:
- Felspar.
 - Silica.
 - Whiting chalk (calcium carbonate).
 - Kaolin.
14. Which of the following is pink or gray in color?
- Gutta-percha points.
 - Silver points.
 - Composite resin.
 - IRM.
 - Calcium hydroxide.

15. Complete information related to dental porcelain.
- Upon cooling, the mass is _____ and _____.
 - The heating process is called _____.
 - Baked porcelain has a _____ similar to that of _____.
16. Match the term in Column II to the range of temperature in Column I. Write your answers in the spaces provided.

<u>COLUMN I</u>	<u>COLUMN II</u>
(1) _____ 2000° to 2400° F.	a. High-fusing porcelain
(2) _____ 1600° to 2000° F.	b. Medium-fusing porcelain
(3) _____ 2400° F or over.	c. Low-fusing porcelain

17. Which of the following dental porcelains is used for the fabrication of full porcelain crowns (jacket crowns)?
- High-fusing porcelain.
 - Medium-fusing porcelain.
 - Low-fusing porcelain.
18. Which of the following polishing materials is used in polishing teeth and metal restorations.
- Pumice.
 - Zirconium silicate.
 - Jeweler's rouge.
 - Tin oxide.
 - Tripoli.

19. Which of the following is the least likely to tarnish or corrode in the mouth?
- a. Silver.
 - b. Gold.
 - c. Amalgam.
20. Is chromium alloy a controlled item subject to strict accountability?
- a. Yes.
 - b. No.
21. How many carats are there in a gold alloy that is 750 fine?
- a. 24.
 - b. 21.
 - c. 18.
 - d. 15.
 - e. 12.
22. In the troy system of weight, how many grains are there in gold that weighs $\frac{1}{2}$ ounce?
- a. 720.
 - b. 460.
 - c. 240.
 - d. 120.

23. List the tooth surfaces where gold foil is most often used.
- _____ surfaces.
 - _____ surfaces of anterior teeth.
 - _____ surfaces of posterior teeth.
24. Which type of casting gold alloy is sometimes used for full crowns?
- Soft.
 - Medium.
 - Hard.
 - Extra hard.
25. Which type of casting gold alloy is sometimes used for one-piece cast partial dentures?
- Soft.
 - Medium.
 - Hard.
 - Extra hard.
26. Which of the following is sometimes used for the construction of clasps?
- Wrought gold.
 - Gold alloy solder.
 - Gold foil.
 - Gold plate.
 - A nonprecious metal alloy.

27. Which of the following is sometimes used for joining the parts of fixed partial dentures or for building up restorations?
- a. Gold foil.
 - b. A nonprecious metal alloy.
 - c. Gold plate.
 - d. Wrought gold.
 - e. Gold alloy solder.

Check Your Answers on Next Page

SOLUTIONS TO EXERCISES, LESSON 2

1. d (para 2-2a)
2. a. Universal
b. Catalyst
c. Quartz (para 2-2b)
3. a. 89
b. 35,000
c. solubility; shrinkage
d. Refrigeration (para 2-2c)
4. a. equal
b. 20 to 30
c. insufficient (para 2-2d)
5. a. uni; cat
b. discoloration (para 2-2d)
6. a. seal
b. 40 to 50
c. 15; 30
d. chalky (para 2-3)
7. a. zinc oxide; polymethyl methacrylate
b. eugenol
c. 1; 1
d. stropped; 5 to 10
e. 60 (para 2-5)
8. d (para 2-6)
9. a (para 2-6)
10. c (para 2-8b)
11. c (para 2-8a)
12. b (para 2-9a)
13. c (para 2-9a)
14. a (para 2-8a)

15. a. hard; dense
b. baking
c. translucency; dental enamel (para 2-9a)
16. (1) b
(2) c
(3) a (paras 2-9b, c, d)
17. a (para 2-9b)
18. d (para 2-10a)
19. b (para 2-11)
20. a (para 2-12)
21. c (para 2-13; Table 2-1)
22. c (para 2-13; Table 2-1)
23. a. Facial
b. Proximal
c. Occlusal (para 2-15)
24. c (para 2-16b(3))
25. d (para 2-16b(4))
26. a (para 2-18)
27. e (para 2-17)

End of Lesson 2

LESSON ASSIGNMENT

LESSON 3

Gypsum Products, Dental Waxes, and Impression Materials.

LESSON ASSIGNMENT

Paragraphs 3-1 through 3-23.

LESSON OBJECTIVES

After completing this lesson, you should be able to:

- 3-1. Identify the characteristics and preparation procedures for plaster of Paris and artificial stone (gypsum products).
- 3-2. Identify the clinical use of seven dental waxes.
- 3-3. Identify the characteristics and preparation procedures for alginate-type hydrocolloid impression materials.
- 3-4. Identify the characteristics and preparation procedures for elastomeric impression materials.
- 3-5. Identify the characteristics of modeling plastic and impression paste.

SUGGESTION

After studying the assignment, complete the exercises at the end of this lesson. These exercises will help you to achieve the lesson objectives.

LESSON 3

GYPSUM PRODUCTS, DENTAL WAXES, AND IMPRESSION MATERIALS

Section I. GYPSUM PRODUCTS

3-1. GENERAL--GYPSUM

a. **General.** A number of gypsum products are used in dentistry. Plaster of Paris and artificial stone powder are the ones most used as cast materials. A general understanding of the chemistry of gypsum products will enable the dental specialist to use them wisely and increase his knowledge of why they react as they do. Gypsum is composed mainly of calcium sulfate dihydrate. A dihydrate is a material consisting of two parts of water to one part of the compound. Calcium sulfate dihydrate, therefore, is one part calcium sulfate and two parts water.

b. **Properties.** In the manufacturing process, gypsum is converted to plaster of Paris and artificial stone by a process called calcining. The gypsum is first ground to a fine powder of particle size. Plaster of Paris is derived when the gypsum is subjected to heat in an open vat. Artificial stone is produced when the gypsum is processed by steam heat under pressure. In both products, the reaction converts calcium sulfate dihydrate into calcium sulfate hemihydrate by the removal of 75 percent of the water molecules. Chemically, the plaster and artificial stone are identical. However, the plaster particles are rough, irregular, and porous, and the artificial stone particles are prismatic, more regular in size, and dense. When the plaster or stone is mixed with water, a hard substance is formed and the process described above is reversed. In the setting reaction, crystals of gypsum intermesh and become entangled with one another, giving the set material its strength and rigidity.

3-2. PLASTER OF PARIS

a. **Uses.** Plaster of Paris is used for pouring casts, making matrices for prosthodontic restorations, for attaching casts to articulators, and general use in the dental laboratory where strength is not important. The crushing strength for plaster of Paris is 2,600 psi.

b. **Mixing.** Water-powder ratios must be used as stated by the manufacturer. Before mixing, the can containing the material should be agitated to evenly disperse all elements in the powder. A clean, dry rubber bowl and plastic spatula are used to manipulate the materials. First, the water is measured and poured into the rubber bowl. The powder is weighed and sifted into the water to avoid trapping air bubbles. Then, with a spatula, the mix is stirred (spatulated) for 30 to 60 seconds in a knifing or stirring motion, making sure to include all powder from the sides of the bowl. (Whipping the mix will entrap air and should be avoided.) Before the mixed material is poured, it should be vibrated to remove any trapped air bubbles.

c. **Setting Time.** The initial setting time for plaster of Paris is 5 to 10 minutes. In this stage, the plaster loses its glossy appearance and is hard enough to hold for carving. The final setting time is approximately 45 minutes. In this stage, the plaster achieves a dry, hard condition. The setting of plaster can be hastened by using less water, by mixing longer, by using chemical accelerators, or by using warm water (up to 85° F (29° C)). Reversing these processes or using chemical retarders lengthens the setting time. The most satisfactory results will be obtained by following the manufacturer's directions.

3-3. ARTIFICIAL STONE

a. **Uses.** Artificial stone is used in making master casts and dies and for general laboratory use when a very hard, strong product is needed. Artificial stone particles are nonporous. Therefore, the finished product is hard and dense. This provides an excellent master cast for the fabrication of prosthetic restorations. The crushing strength of artificial stone is 7,500 psi.

b. **Mixing.** Artificial stone is mixed much like plaster of Paris. The average mixing ratio is 30 cc (cubic centimeters) of water to 100 grams of stone powder. This ratio may vary with different manufacturers. The required amount of water is placed in a rubber bowl. The stone powder is added slowly. (Incorporate all of the powder with water before spatulating.) Spatulation should be thorough without whipping the mixture. Whipping can trap air bubbles, thus weakening the cast. The bowl should be vibrated during the mixing to make air bubbles rise to the surface. Spatulation should be completed in 30 to 60 seconds; after that, the bowl should again be vibrated. The use of mechanical spatulation helps to reduce air bubbles.

c. **Setting Time.** The initial setting time for artificial stone is usually 8 to 10 minutes. The final setting time is 25 to 45 minutes depending on the type of stone mixed. The surface hardness of artificial stone can be increased by soaking the cast for several hours in a solution of borax.

Section II. DENTAL WAXES

3-4. GENERAL--WAXES

Many different waxes are used in dentistry. The composition, form, and color of each wax are designed to facilitate its use and to produce the best possible results. The discussion in this lesson is limited to aspects of clinical interest.

3-5. INLAY WAX

a. **General.** Inlay wax is used to prepare patterns. These patterns are reproduced in gold or other material in the fabrication of inlays, crowns, and fixed and removable partial dentures. Inlay wax is sometimes called casting wax.

b. **Properties.** For success in these procedures, the wax must have properties which will enable very close adaptation to the prepared portions of the tooth to be restored, must provide freedom from distortion, must permit detailed carving without flaking or chipping, and must not leave excessive residue when it is removed from a mold by burning. The wax should harden at body temperature, but soften at a temperature low enough to permit it to be manipulated in a plastic state in the mouth without injury to pulp or oral tissues. Its color should contrast with the colors of teeth and oral tissues to facilitate carving, except that ivory wax is used to avoid risk of color contamination when porcelain or acrylic restorations are constructed. Because of the importance of certain qualities of these waxes, the ADA has developed certain specifications with which an inlay wax must comply to be acceptable.

c. **Usage.** Inlay wax is available in blue, green, ivory, or deep purple sticks, in preformed shapes for partial dentures, and in solidly packed cans. It is hard at room temperatures and breaks if bent sharply. This wax remains hard at mouth temperature and may be carved either in or out of the mouth. It is softened with dry heat or by immersion in warm water until pliable.

3-6. BASEPLATE WAX

a. **General.** Baseplate wax is used mainly for making occlusion rims and for holding artificial teeth to baseplates during the fabrication of dentures.

b. **Properties.** Baseplate wax is composed mainly of beeswax, paraffin, and coloring matter, which are mixed together, cast into blocks, and rolled into sheets. The sheets are red or pink and are 3 inches wide and 6 inches long. Baseplate wax is relatively hard and slightly brittle at room temperature, but becomes soft and pliable when heated.

c. **Usage.** Baseplate wax must be capable of holding porcelain or acrylic teeth in position both at normal room temperature and at mouth temperature.

d. **Two Types.** There are two types of baseplate wax, hard and medium, listed in the Federal Supply Catalog. The hard type is suitable for use in warm climates, but tends to crack and flake at low temperatures. The medium type is suitable for use at low temperatures, but flows excessively at high temperatures.

3-7. STICKY WAX

a. **General.** Sticky wax has many uses in a dental clinic and dental laboratory. It holds broken pieces of a denture together and assembles components of fixed partial dentures and wrought partial dentures in preparation for soldering.

b. **Properties.** Sticky wax becomes sticky when melted and has the property of adhering to the surfaces of various materials. Sticky wax is composed of beeswax, paraffin, and resins. It is usually supplied as hexagonal sticks of various colors, often orange or purple. It is brittle at room temperature and assumes a thick, liquid consistency when heated.

3-8. UTILITY WAX

Utility wax is used to provide rim locks and otherwise adapt impression trays for individual impressions, to build up post-dam areas on impressions, and to form a bead or border on preliminary and final impressions. Utility wax is pliable enough at room temperature to use without heating. Utility wax is normally issued in stick form and is usually red in color. When it is supplied in rope form, it is sometimes called rope wax.

3-9. DISCLOSING WAX

Disclosing wax is used to determine unequal pressure points in a denture that may cause discomfort to the patient. These points are located by painting the wax on the tissue side of the denture base and holding the denture in place under pressure in the mouth. The wax flows away from the points needing relief. Disclosing wax is sometimes known as pressure indicator paste.

3-10. BOXING WAX

Boxing wax is used to form a box around impressions of the mouth when making a cast (model). The boxing limits the flow of either plaster of Paris or artificial stone gypsum material. Boxing wax is usually issued in red strips measuring 1 1/2 inches wide, 12 inches long, and 1/8 inch thick. Boxing wax is soft and pliable enough at room temperature to be formed into a desired shape without heating. For further softening, a strip of wax can be passed through an open flame.

3-11. LOW-FUSING IMPRESSION WAX

Low-fusing impression wax is a wax that is especially compounded so that, when subjected to controlled pressure, it will flow to some extent in the mouth. Its main ingredient, spermaceti, is obtained from the head of the sperm whale. Low-fusing impression wax is often used in relining or rebasing complete and partial dentures. Because it is easily distorted, impressions must be handled with care. Boxing is not recommended. Separators are not necessary when pouring the cast.

Section III. IMPRESSION MATERIALS

3-12. GENERAL

An impression is a negative reproduction of a given area of the oral cavity. The area reproduced may be composed of either hard or soft tissues or both. The material must be inserted into the mouth while it is too soft to retain its shape. A rigid base is needed to carry it to the mouth and hold it against the tissues until it hardens. For this purpose, a variety of trays, called stock trays, are available. These are shaped to fit over the average maxillary and mandibular arches. Some can be trimmed and bent to the requirements of the individual patient. Trays may also be fabricated for each individual patient.

3-13. REQUIREMENTS FOR IMPRESSION MATERIAL

a. **General.** An impression material must meet a wide range of requirements in order to provide an accurate impression of the different tissues.

b. **List of Requirements.** The following are some of the more important requirements.

(1) The material should flow or be pliable at a temperature that will not injure the oral tissue.

(2) It should set quickly, preferably within 2 to 4 minutes, at body temperature.

(3) It should unite into a solid mass without adhering to the oral tissues or to the material used for the cast.

(4) It should fall into all irregularities and fine lines in the area to reproduce without displacing soft tissue.

(5) It must retain an accurate reproduction of surface detail when it solidifies and is withdrawn from the mouth.

(6) It must have dimensional stability. It must not expand, contract, or become deformed in any way because of temperature changes, atmospheric conditions, or the pouring of the cast.

(7) It must not be too unpleasant to the patient.

(8) It must not flake (after solidifying) when trimmed with a sharp knife at room temperature.

3-14. TYPES OF IMPRESSION MATERIALS

Impression materials are of three types: the rigid type, the thermoplastic type, and the elastic type. Thermoplastic materials soften when warmed and harden when cooled with no change in chemical makeup. Elastic materials expand and contract with no change in structure or shape. All three types have advantages and disadvantages. The dental officer determines which material best meets the requirements of each particular case. He frequently will use two or more materials to make a single impression.

3-15. ALGINATE-TYPE HYDROCOLLOID -- CHARACTERISTICS

a. **General.** The alginate-type hydrocolloids are an elastic type impression material. An alginate is a salt of alginic acid (an extract from seaweed). Alginate-type hydrocolloids gel by chemical action. Once the gelation process begins, it is irreversible.

b. **Composition.** The composition of the alginate-type hydrocolloids varies with different manufacturers. The basic components are a soluble alginate (either potassium alginate or sodium alginate) and a reactor (calcium sulfate) that causes the alginate to gel. The product also contains a retarder (sodium or potassium sulfate, oxalate, or carbonate) to prevent gelation from occurring too rapidly. A fluoride is usually added to prevent retardation of the setting time of the casts. The remainder of the material is composed of fillers that increase the strength and stiffness of the gel.

c. **Usage.** Alginate-type hydrocolloids are supplied in powder form, either in bulk or in measured portions packaged in foil envelopes. The powder must be stored in a cool place. The bulk form must be kept in a tightly closed container to protect it from contamination and to prevent it from absorbing moisture from the air. The containers are agitated to loosen the bulk powders before they are measured, thus preventing use of an excessive proportion of the powder. The powder is mixed with a measured amount of water. Further discussion follows below.

3-16. DISPENSING

Water and powder measuring cups are provided by the manufacturer in each can of alginate-type material. Lines on the water measurer correspond to the number of scoops of powder used. The ratio of use is 1 to 1 (for example, three scoops of powder to three units of water). The actual amount will vary, depending on the size of the impression tray. Prior to mixing, it is necessary to tumble the container in order to fluff the powder.

3-17. MIXING AND SETTING TIME

The best method of controlling the gelation time of alginate-type hydrocolloid materials is to alter the temperature of the water used in the mix. The higher the temperature of the water, the faster gelation will occur. Higher temperatures accelerate the chemical reaction. The temperature of the water must be regulated carefully within a few degrees of that recommended by the manufacturer to obtain a constant and reliable gelation time. The average recommended temperature of water is 70° F (21° C). Changing the water-powder ratio and the mixing time will alter the gelation time, but these methods of control also impair certain properties of the material. The amount of the retarder in the material can be regulated only by the manufacturer since the action of the retarder changes the nature of the material.

3-18. STRENGTH

The water-powder ratio recommended by the manufacturer must be used. Too little or too much water will weaken the gel. Mixing must be timed. Undermixing may prevent the chemical reaction from occurring evenly, and overmixing may break up the gel. Either can decrease the strength of the material by as much as 50 percent. The strength of alginate-type hydrocolloids increases for several minutes after the initial gelation. Consequently, the impression must not be removed from the mouth for at least 2 or 3 minutes after gelation has occurred.

3-19. DIMENSIONAL STABILITY

Alginate-type hydrocolloid impression materials are influenced by syneresis, imbibition, strain, and stress. Hence, for the most accurate results, the impression should be fixed and the cast poured soon after the impression is removed from the mouth. If the impression must be stored for a short period of time, it should be placed in a humidior in which the relative humidity is 100 percent.

3-20. EFFECT ON GYPSUM PRODUCTS

Alginate-type hydrocolloid impression materials affect gypsum products in the same manner as the agar-type materials affect them. Some alginates do not require the use of hardening solutions because the manufacturer has incorporated these materials in the powder. However, the hardness of the surfaces of the cast can always be improved by "fixing" the impression with a hardening solution.

3-21. ELASTOMERIC IMPRESSION MATERIALS-- CHARACTERISTICS

a. **General.** Elastomeric impression materials have greater dimensional stability with time and ability to record precise details. The first materials were polysulfides (rubber base), followed by condensation silicones, poletthers and addition silicones (polyvinyl siloxanes). Polyvinyl siloxane impressions are currently the most used, followed by polyether.

b. **Two-Part Systems.** All of the elastomeric impression materials consist of two-part system. Generally, they consist of two-paste or putty components that are manually mixed with a spatula and pad. Most are available in cartridge form for use in an automix impression gun.

c. **Usage.** A thin layer of this material, uniform in thickness, is required to obtain the most accurate impression with the material. For this reason, it is used in individually designed (custom) acrylic resin trays. Synthetic elastomeric materials are not adhesive; therefore, a tray adhesive is needed to prevent the impression from pulling away from the tray. If the impression material pulls away from the tray, distortion will result when the tray is removed from the patient's mouth.

d. **Summary.** The properties of elastomeric impression materials are summarized in table 3-1.

PROPERTY	POLYSULFIDE	POLYVINYL	POLYETHER
Working Time	Long	Medium	Short
Setting Time	Long	Medium	Short
Shrinkage on Setting	High	Very Low	Low
Flexibility	High	Medium	Low
Tear Strength	High	Medium	Low
Gypsum Wettability	Medium	Poor to Good	Good
Detail	Excellent	Excellent	Excellent

Table 3-1. Mechanical and physical properties of elastomeric impression materials.

3-22. MODELING PLASTIC--CHARACTERISTICS

a. **General.** Modeling plastic (modeling composition) is an impression material (thermoplastic type) which can be softened by heat into a soft plastic mass and then hardened by cooling with either a stream of cold water or a blast of air. Modeling plastic is used primarily to make impressions of the edentulous arches (the tooth ridges without teeth).

b. **Properties and Materials.** Modeling plastic is composed of shellac, talc, and glycerides derived from certain tallow oils. The temperature range at which softening occurs depends upon the proportions of the ingredients contained in the material. Modeling plastic is supplied in cakes, wafers, or sticks and in various colors to aid in distinguishing between products of different softening (fusing) temperature ranges.

c. **Recommended Procedures.** Any of the gypsum products can be poured against a modeling plastic impression without the use of a separator. Also, modeling plastic is one of the impression materials against which an amalgam die can be packed. (An amalgam die is a model of a tooth in silver amalgam, used for making an inlay or crown.) Although no separating medium is required in either of these procedures, extreme care must be exercised in drawing the impression material from the cast or die since both materials are hard and relatively unyielding. Therefore, the modeling plastic is softened in water heated to 120° F (49° C) and removed gently so that the cast is not damaged.

3-23. IMPRESSION PASTE--CHARACTERISTICS

a. **General.** Impression paste is a thermoplastic-type impression material. It is usually supplied as two separate units--a base and a hardener. The principal ingredients are zinc oxide and eugenol. When the base and the hardener are mixed together in specific proportions, they form a paste. No separator is required when pouring the cast in an impression taken with this material.

b. **Usage.** Impression paste is used primarily as a corrective material inside an individual impression tray. It is also widely used for rebase impressions for both complete and partial dentures. (A rebase impression replaces the base material of a denture without changing the occlusal relations of the teeth.) Occasionally, it is used in immediate denture fabrication as a lining for a sectional compound impression. Impression paste can be used to provide a lining for a complete denture baseplate to make it fit both the cast and the mouth accurately.

Continue with Exercises

EXERCISES, LESSON 3

INSTRUCTIONS: Answer the following exercises by marking the lettered response that best answers the question or best completes the incomplete or by writing the answer in the space provided.

After you have completed all the exercises, turn to "Solutions to Exercises" at the end of the lesson and check your answers.

1. Select the dental material below that is one part calcium sulfate and two parts water.
 - a. Hydrocolloid impression materials.
 - b. Calcium hydroxide.
 - c. Modeling plastic.
 - d. Dental wax.
 - e. Gypsum.

2. Which of the following cast materials is processed by steam heat under pressure?
 - a. Plaster of Paris.
 - b. Artificial stone.

3. What percentage of water is removed from the raw material to produce plaster of Paris or artificial stone?
 - a. 100 percent.
 - b. 75 percent.
 - c. 50 percent.
 - d. 33 percent.

4. Which of the following has particles that are rough, irregular, and porous?
- a. Plaster of Paris.
 - b. Artificial stone.
5. The psi for artificial stone is:
- a. 2,600.
 - b. 5,000.
 - c. 7,500.
 - d. 12,000.
6. Match the use or description of the product in Column I to the product in Column II. Write your answers in the spaces provided.

COLUMN I

COLUMN II

- | | | | |
|-----------|---|----|------------------|
| (1) _____ | Make hard, strong master casts | a. | Plaster of Paris |
| (2) _____ | Make matrices for prosthodontic restorations | b. | Artificial stone |
| (3) _____ | Make hard, strong dies | | |
| (4) _____ | Attach casts to articulators | | |
| (5) _____ | Prismatic, more regular in shape, dense, nonporous. | | |
| (6) _____ | Rough, irregular, porous. | | |

7. Complete information related to the steps in the sequence of mixing either plaster of Paris or artificial stone.
 - a. Obtain a clean, dry _____ bowl.
 - b. Obtain a _____ spatula.
 - c. _____ is measured and poured into the bowl.
 - d. Powder is _____ into the water.
 - e. All the powder from the _____ of the bowl must be included in the mix.
 - f. Avoid trapping _____

8. Describe the process of spatulation used in mixing gypsum products.
 - a. With the spatula, stir the mix for _____ to _____ seconds.
 - b. Use a _____ or _____ motion.
 - c. _____ the mix will entrap air bubbles and weaken the cast.
 - d. _____ the mixed material in the bowl to remove trapped air bubbles.

9. Initial setting time for plaster of Paris is:
 - a. 5 to 10 minutes.
 - b. 8 to 10 minutes.

10. Following the initial setting time, _____ becomes hard enough to hold for carving.
 - a. Plaster of Paris.
 - b. Artificial stone.

11. Final setting time for artificial stone, depending of the type mixed, is:
 - a. 10 to 25 minutes.
 - b. 25 to 45 minutes.

12. List the methods used to hasten the setting time for gypsum plaster products.
 - a. Use _____ water.
 - b. Mix for a _____ period of time.
 - c. Use a _____ accelerator.
 - d. Use warm water, up to _____ F.

13. Soaking the cast for several hours in a solution of borax will increase the surface hardness of:
 - a. Plaster of Paris.
 - b. Artificial stone.

14. Match the common use in Column I to the appropriate dental wax in Column II. Write your answers in the space provided.

<u>COLUMN I</u>	<u>COLUMN II</u>
(1) _____ Used to prepare patterns for crowns	a. Utility wax
(2) _____ Used for making occlusal rims	b. Boxing wax
(3) _____ Holds together broken pieces of a denture	c. Low-fusing impression wax.
(4) _____ Adapts impression trays for individual impressions	d. Inlay casting wax.
5) _____ Forms a box around impressions	e. Baseplate wax
(6) _____ Used in relining or rebasing partial dentures	f. .Sticky wax

15. Match the shape, color, and/or size in Column I to the appropriate dental wax in Column II. Write your answers in the space provided.

COLUMN I

COLUMN II

- | | | | |
|-----------|---|----|-------------------|
| (1) _____ | Blue, green, ivory, and deep purple sticks | a. | Sticky wax |
| (2) _____ | Red or pink sheets (3" X 6") | b. | Utility wax |
| (3) _____ | Hexagonal sticks, orange or purple in color | c. | Boxing wax |
| (4) _____ | Stick form (red color) or rope form. | d. | Inlay casting wax |
| (5) _____ | Red strips (1 1/2" X 12") | e. | Baseplate wax |

16. Select the dental wax that is relatively hard and slightly brittle at room temperature, but becomes soft and pliable when heated.

- a. Utility wax.
- b. Disclosing wax.
- c. Boxing wax.
- d. Baseplate wax.
- e. Low-fusing impression wax.

17. Select the dental wax that is pliable enough at room temperature to use without heating.

- a. Inlay casting wax.
- b. Baseplate wax.
- c. Sticky wax.
- d. Disclosing wax.
- e. Utility wax.

18. What dental wax is used to determine unequal pressure points in a denture that may cause discomfort to a patient?
- a. Sticky wax.
 - b. Utility wax.
 - c. Disclosing wax.
 - d. Low-fusing impression wax.
19. Which dental wax permits detailed carving without flaking or chipping and can be manipulated in the mouth without injury to oral tissues?
- a. Boxing wax.
 - b. Inlay (casting) wax.
 - c. Utility wax.
 - d. Low-fusing impression wax.
 - e. Baseplate wax.
20. Which dental wax must be capable of holding porcelain or acrylic teeth in position both at normal room temperature and at mouth temperature?
- a. Baseplate wax.
 - b. Sticky wax.
 - c. Inlay casting wax.
 - d. Boxing wax.
 - e. Low-fusing impression wax.

21. Which dental wax is often used in relining or rebasing complete and partial dentures, but must be handled with care because it is easily distorted?
- a. Baseplate wax.
 - b. Disclosing wax.
 - c. Inlay casting wax.
 - d. Sticky wax.
 - e. Low-fusing impression wax.
22. Which dental wax is usually supplied either in stick form (red in color) or in rope form?
- a. Inlay casting wax.
 - b. Utility wax.
 - c. Boxing wax.
 - d. Sticky wax.
 - e. Baseplate wax.
23. When making a cast (model), which wax is used to limit the flow of plaster of Paris or artificial stone gypsum material?
- a. Disclosing wax.
 - b. Utility wax.
 - c. Boxing wax.
 - d. Inlay casting wax.
 - e. Sticky wax.

24. Complete information related to impression materials.
- An impression is a _____ reproduction of a given area of the oral cavity.
 - Impression material must be inserted into the mouth while it is too _____ to retain its _____ .
 - _____ _____ carry the impression material to the mouth and provide a _____ base to hold it against the tissues until it hardens.
 - Stock trays may be _____ for each individual patient.
25. Describe some requirements for impression material.
- Impression material should _____ or be _____ at a temperature that will not injure the oral tissue.
 - Impression material should set within _____ to _____ minutes, at body temperature.
 - It must retain an accurate _____ when it solidifies and is withdrawn from the mouth.
 - After solidifying, it must not _____ when trimmed withh a sharp knife at room temperature.
26. Which type of impression material softens when warmed and hardens when cooled, with no change in chemical makeup?
- Rigid.
 - Elastic.
 - Thermoplastic.

27. Which type of impression material expands and contracts with no change in structure or shape?
- a. Rigid.
 - b. Elastic.
 - c. Thermoplastic.
28. Calcium sulfate is the chemical reactor for:
- a. Silicone.
 - b. Elastomeric impression materiall.
 - c. Alginate-type hydrocolloid.
 - d. Impression wax.
29. Select the impression material that uses water and powder in a one to one ratio.
- a. Elastomeric impression material.
 - b. Modeling plastic.
 - c. Sticky wax.
 - d. Impression paste.
 - e. Alginate-type hydrocolloid.

30. Which of the following impression materials is supplied in stick form or as wafers or cakes and uses various colors to indicate different softening temperature ranges?
- a. Elastomeric impression material.
 - b. Impression wax.
 - c. Impression paste.
 - d. Alginate-type hydrocolloid.
 - e. Modeling plastic.
31. Select the impression material used for rebase impressions for both complete and partial dentures and that is also used to provide a lining for a complete denture baseplate.
- a. Elastomeric impression material.
 - b. Modeling plastic.
 - c. Sticky wax.
 - d. Impression paste.
 - e. Alginate-type hydrocolloid.
32. Which impression material is composed of shellac, talc, and glycerides derived from certain tallow oils?
- a. Modeling plastic.
 - b. Impression wax.
 - c. Impression paste.
 - d. Alginate-type hydrocolloid.
 - e. Elastomeric impression material.

Check Your Answers on Next Page

SOLUTIONS TO EXERCISES, LESSON 3

1. e (para 3-1a)
2. b (para 3-1b)
3. b (para 3-1b)
4. a (para 3-1b)
5. c (para 3-3a)
6. (1) b
(2) a
(3) b
(4) a
(5) b
(6) a (paras 3-2a, 3-3a)
7. a. rubber
b. plastic
c. Water.
d. sifted
e. sides
f. air bubbles (paras 3-2b, 3-3b)
8. a. 30 to 60
b. knifing; stirring
c. Whipping
d. Vibrate (paras 3-2b, 3-3b)
9. a (para 3-2c)
10. a (para 3-2c)
11. b (para 3-3c)
12. a. less
b. longer
c. chemical
d. 85° (para 3-2c)
13. b (para 3-3c)

14. (1) d
(2) e
(3) f
(4) a
(5) b
(6) c (paras 3-5 through 3-11)
15. (1) d
(2) e
(3) a
(4) b
(5) c (paras 3-5 through 3-10)
16. d (para 3-6b)
17. e (para 3-8)
18. c (para 3-9)
19. b (para 3-5b)
20. a (para 3-6c, d)
21. e (para 3-11)
22. b (para 3-8)
23. c (para 3-10)
24. a. negative
b. soft; shape
c. Stock trays; rigid
d. fabricated (para 3-12)
25. a. flow; pliable
b. 2 to 4
c. reproduction
d. flake (para 3-13)
26. c (para 3-14)
27. b (para 3-14)
28. c (para 3-15b)
29. e (para 3-16)

30. e (para 3-22b)

31. d (para 3-23)

32. a (para 3-22b)

End of Lesson 3